

# B

# G



موسسه زبان دهخدا  
dehkhodaedu.com

# ENGLISH

STARTER



**Linnette Ansel • Lisa Broomhead**

Mario Herrera • Christopher Sol Cruz

**ACTIVITY BOOK**

ALWAYS LEARNING

**PEARSON**

dehkhodaedu.com



# Stickers

## Unit 1, page 100



## Unit 2, page 100

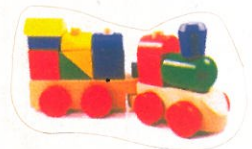
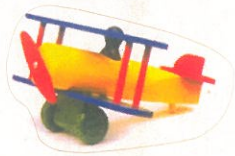

دهخدا

موسسه زبان دهخدا  
dekhodaedu.com



## Unit 3, page 101

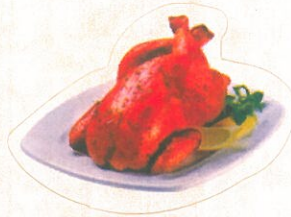
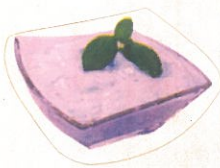
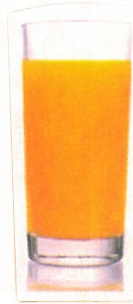

## Unit 4, page 101

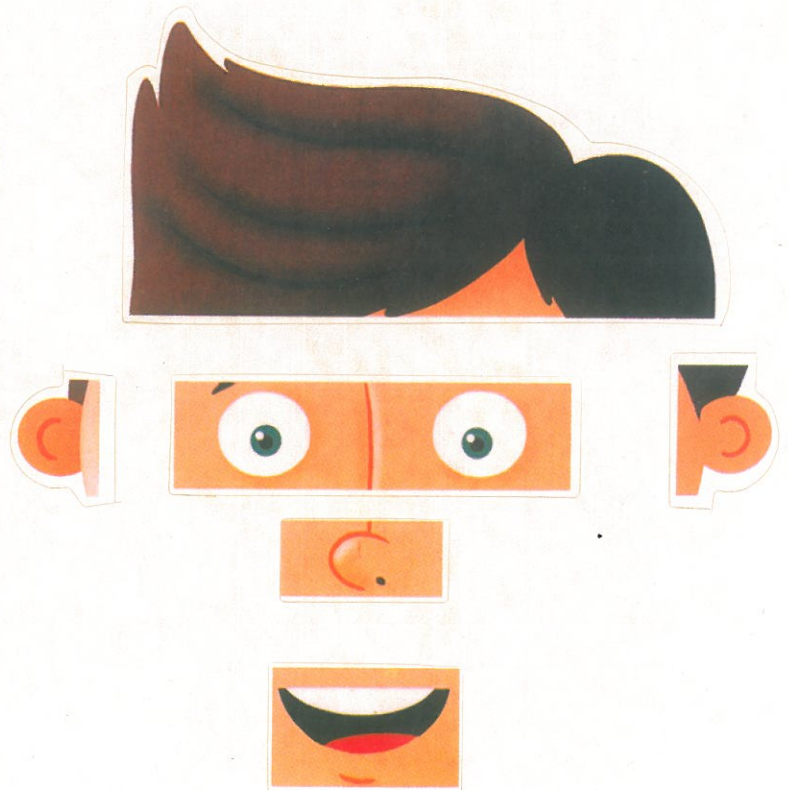



## Unit 5, page 102





# Stickers

## Unit 6, page 102



## Unit 7, page 103





# BIG

## ENGLISH

STARTER

### Contents

	<b>Welcome to class!</b> .....	2
1	<b>My Family</b> .....	4
2	<b>Happy Birthday!</b> .....	14
3	<b>I like cake!</b> .....	24
	<b>Checkpoint</b> Units 1–3.....	34
4	<b>My Body</b> .....	36
5	<b>Around Town</b> .....	46
6	<b>She's swinging on the swings!</b> .....	56
	<b>Checkpoint</b> Units 4–6.....	66
7	<b>It's sunny!</b> .....	68
8	<b>My House</b> .....	78
9	<b>A fish can swim!</b> .....	88
	<b>Checkpoint</b> Units 7–9.....	98
	<b>Picture Dictionary</b> .....	100
	<b>Stickers</b>	



# Welcome to class!



Listen and match.

1

2

3

4

a



b



c



d



Count and write. Say.

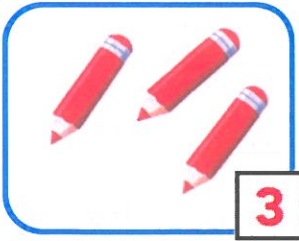

3

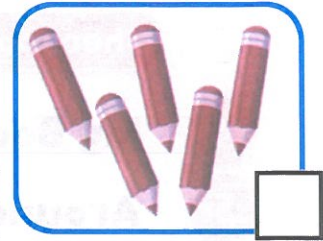
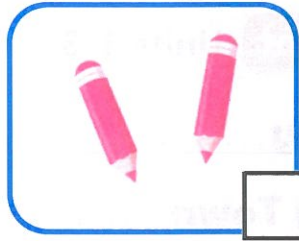
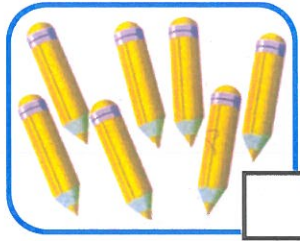

Draw and write how old you are. Say.







# Listen and colour.

1

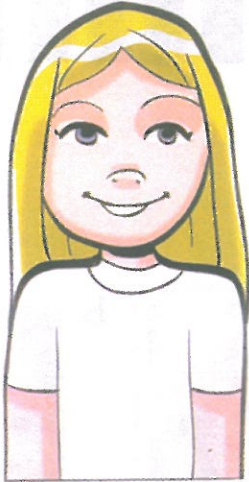

2



3



4



# Listen and ✓ or X.

1



2



3

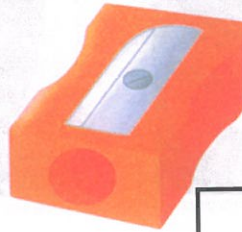

4



# Complete and say.

1

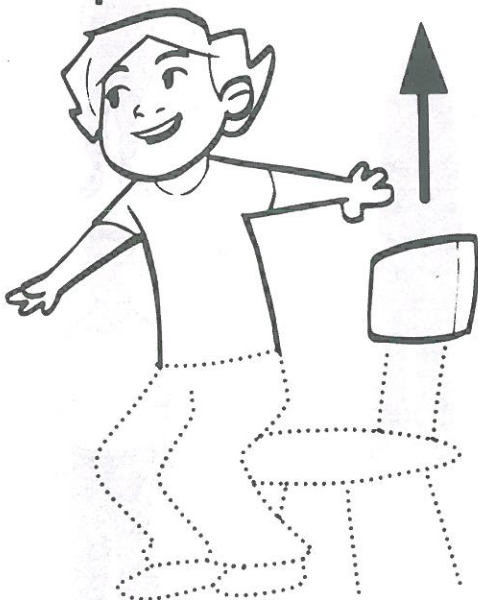

2



3

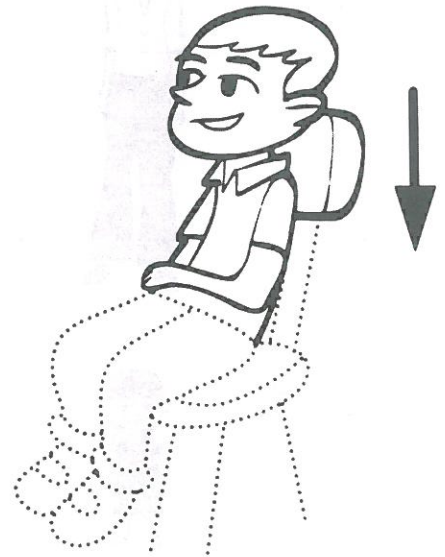

# unit 1

# My Family



1 Listen and circle.

1 a



b



2 a



b



3 a



b



4 a



b



2 Match and say.

1



2



3



4







Look and number. Sing. 🎵







 1

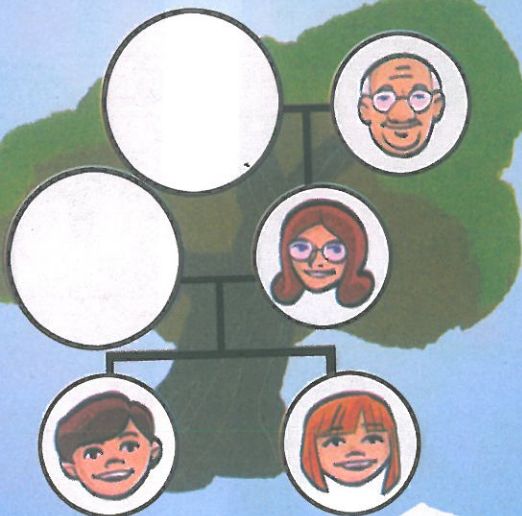

**THINK  
BIG**

Who's missing? Draw and say.





4 Number in order. Tell the story.

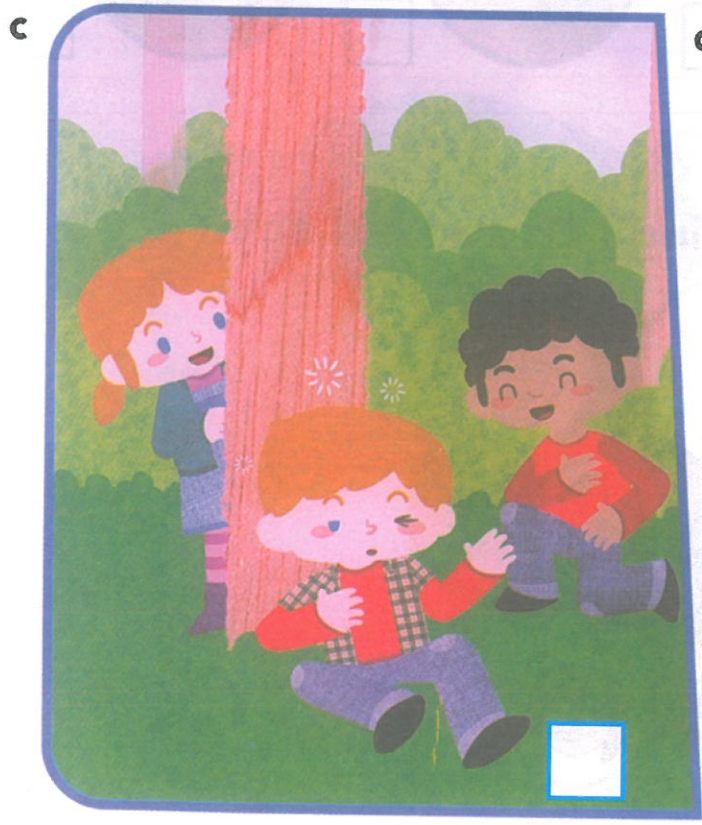





Listen and colour.



1



2

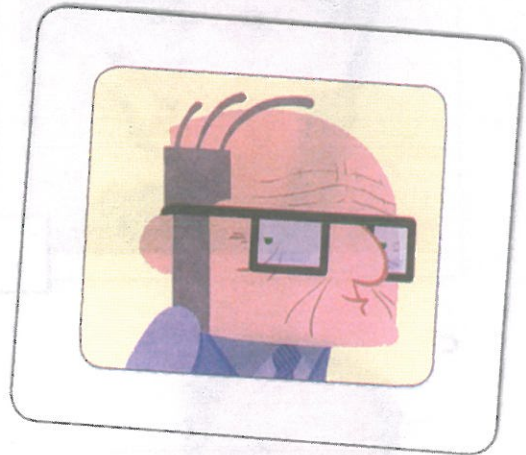

3



4



5

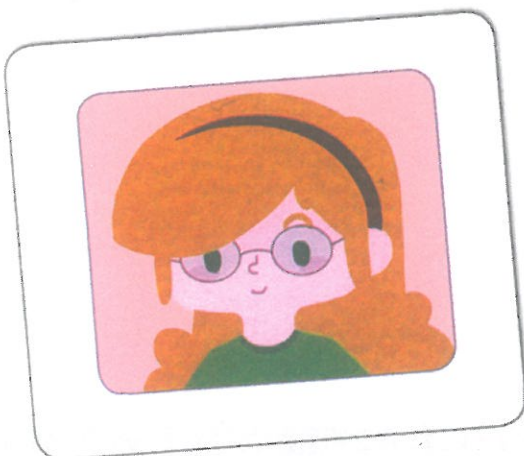

6

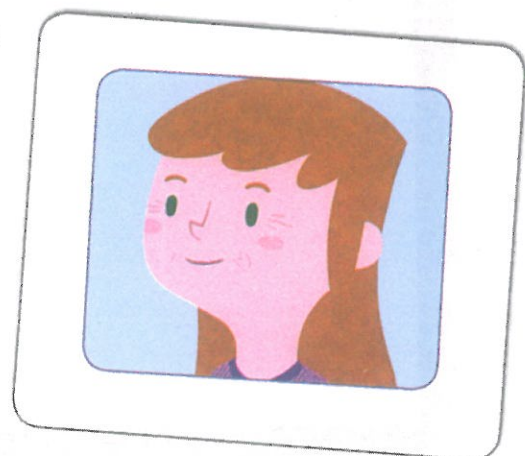

1:29  
6

Listen and number.

a



b



c



d

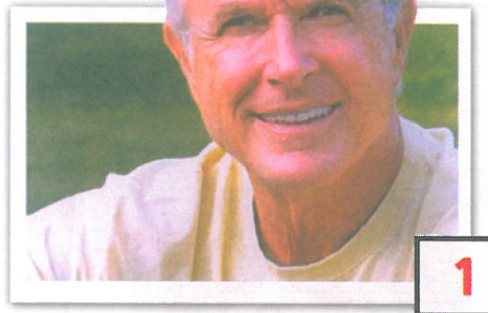

7

Draw and say.





1:32  
8

Listen and ✓ or X.

1



2



3

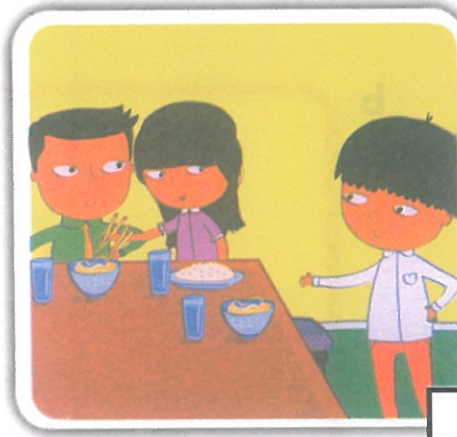

4



**THINK  
BIG**

Look and match.

1

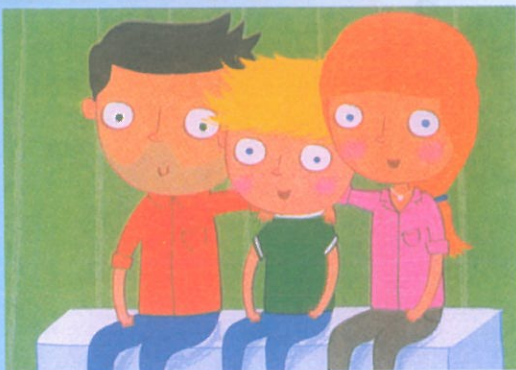

a



c



b



9 Look and draw. Say.

1 a



X

b



✓

2 a



X

b

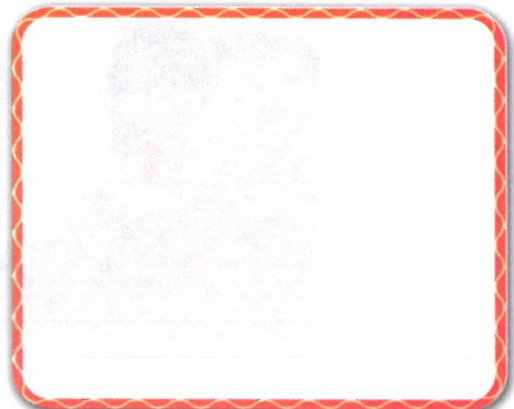

✓

3 a



X

b

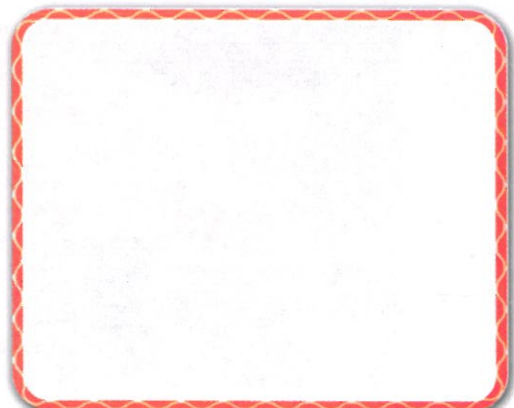

✓



10 Look and match.

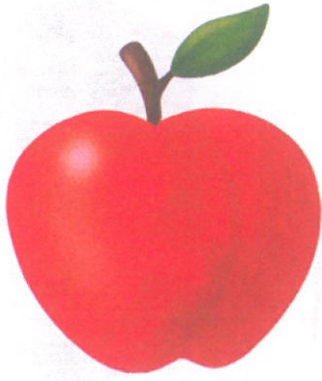

11 Circle the odd one out. Say.

Look and match.

1



2

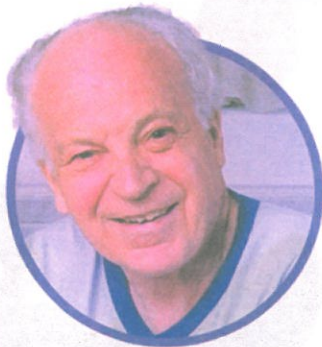

3



4







Listen and ✓.

1 a



b



2 a



b



3 a



b



4 a



b



# Happy Birthday!

**1** Listen, find and colour.

1

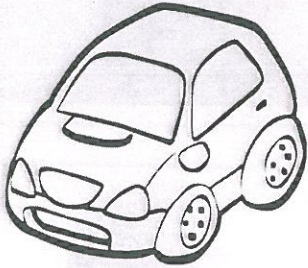

2

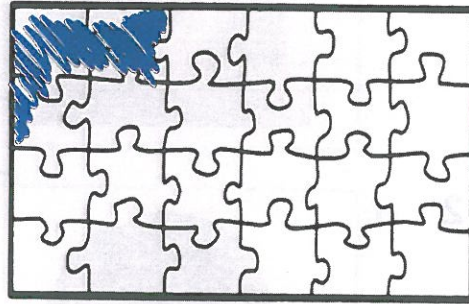

3

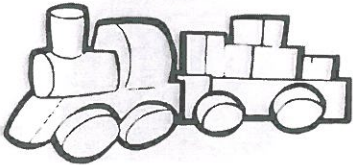

4



**2** Complete and say.

1

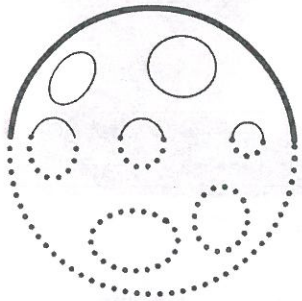

2

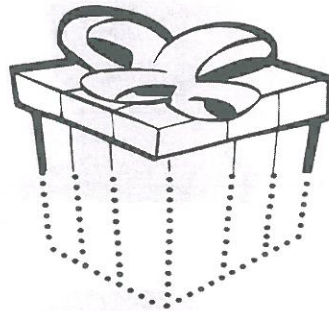

3

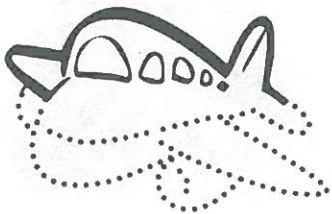

4





Listen and number in order. Sing. 🎵

a

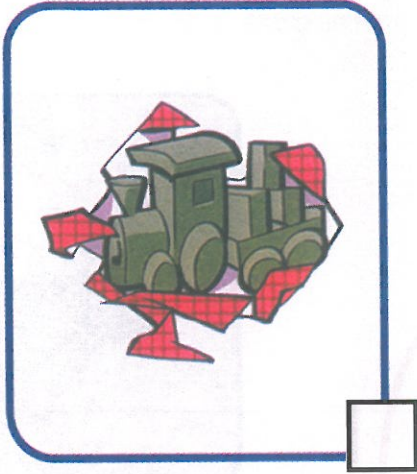

b



c

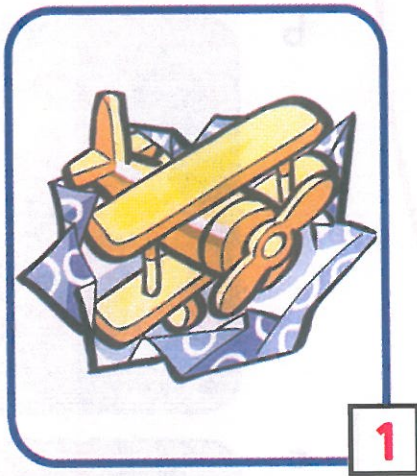

d

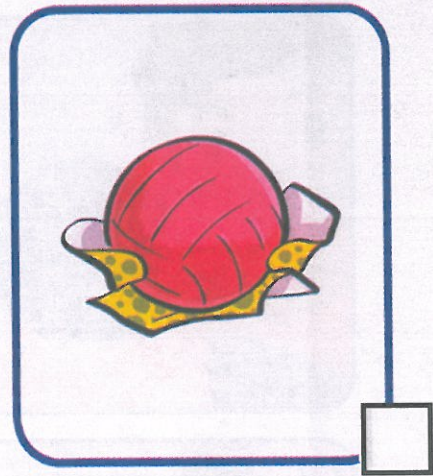

**THINK  
BIG**

Find, circle and say.

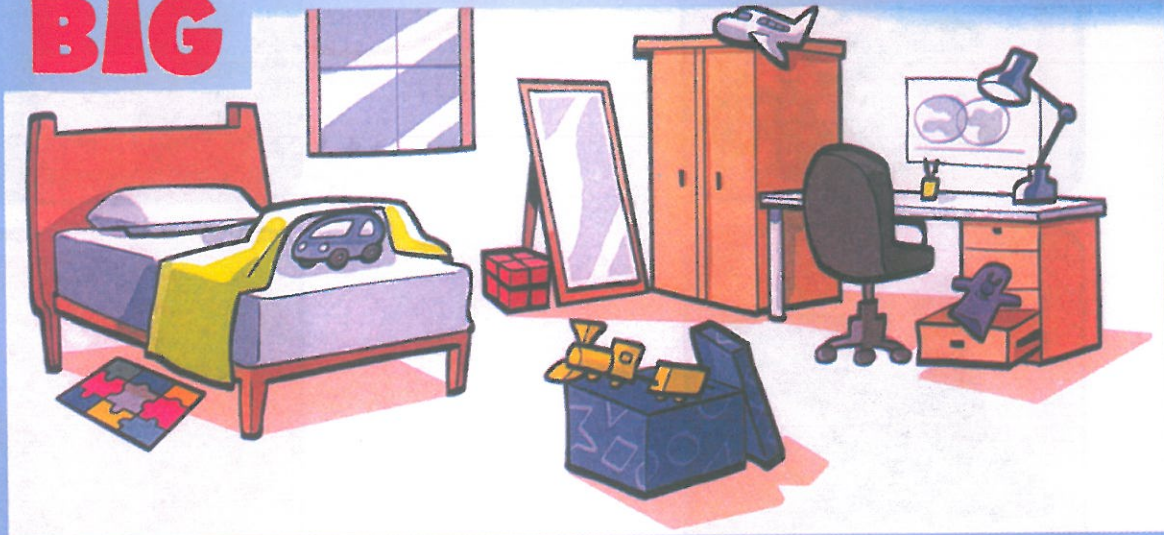



4 Look, match and say.

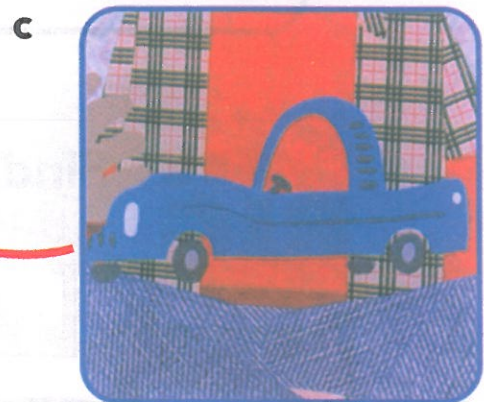
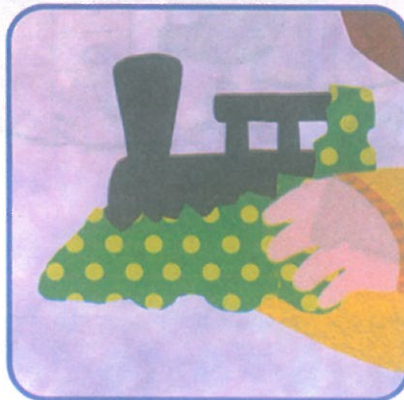







1:49  
5

Listen and ✓.



1

a	b
	
<input type="checkbox"/>	<input checked="" type="checkbox"/>



2

a	b
	
<input type="checkbox"/>	<input type="checkbox"/>

3

a	b
	
<input type="checkbox"/>	<input type="checkbox"/>

4

a	b
	
<input type="checkbox"/>	<input type="checkbox"/>

6 Find, colour and say.

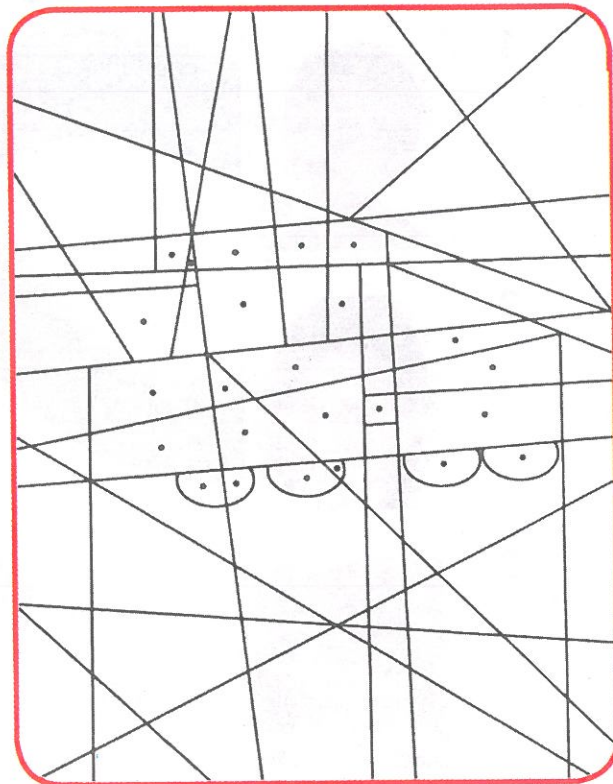
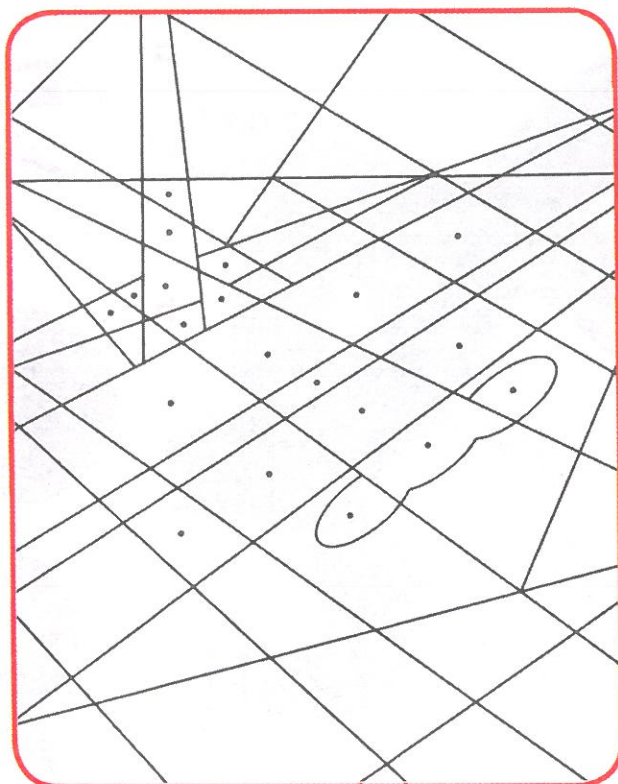

1:57  
7



Listen and ✓.

				
1				✓
2				
3				
4				





8

Find, match and say.

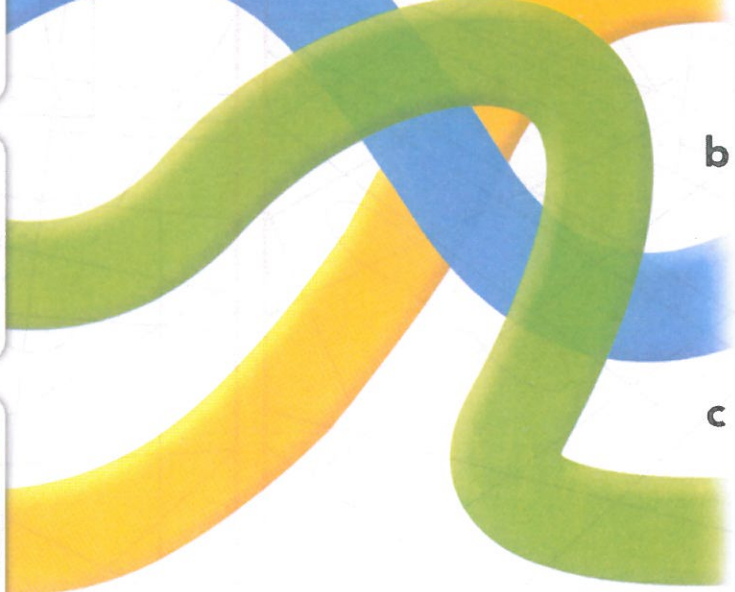
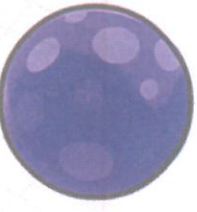
1   a 

2   b 

3   c 





Listen and number.

a



1

b



c



d



**THINK BIG**

Look, match and say.

1



a



b



2

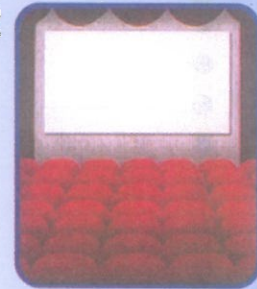

d



c

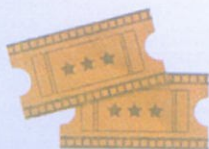



Listen and match. Say.

1

2

a



b



11

Draw and say.





12 Find and colour. Say.



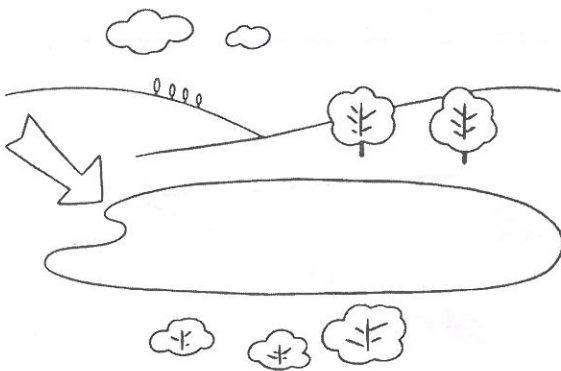
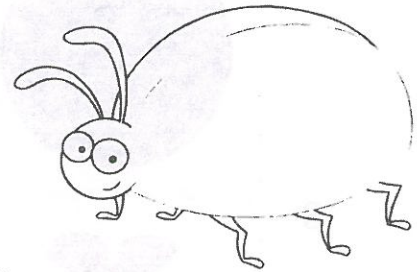
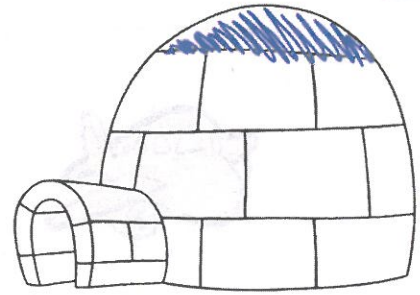
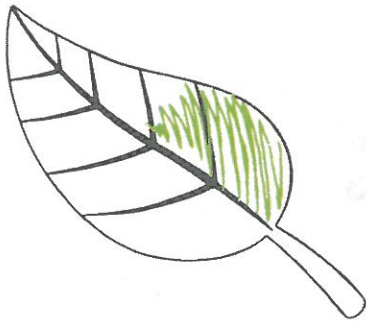



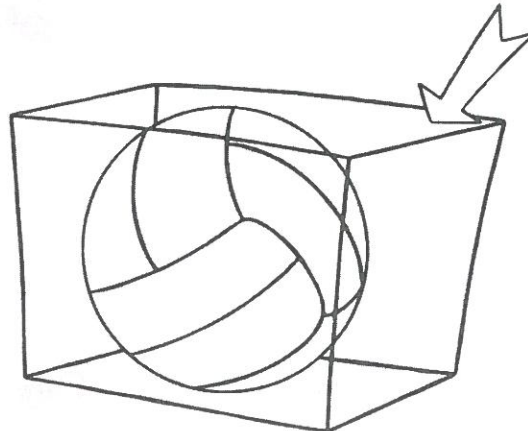



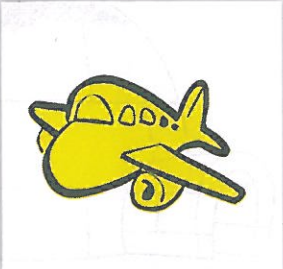

Look and draw. Say.

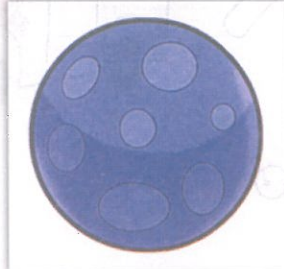

10



## 13 Look and draw. Say.

1				
2				
3				

## 14 Count and draw. Say.

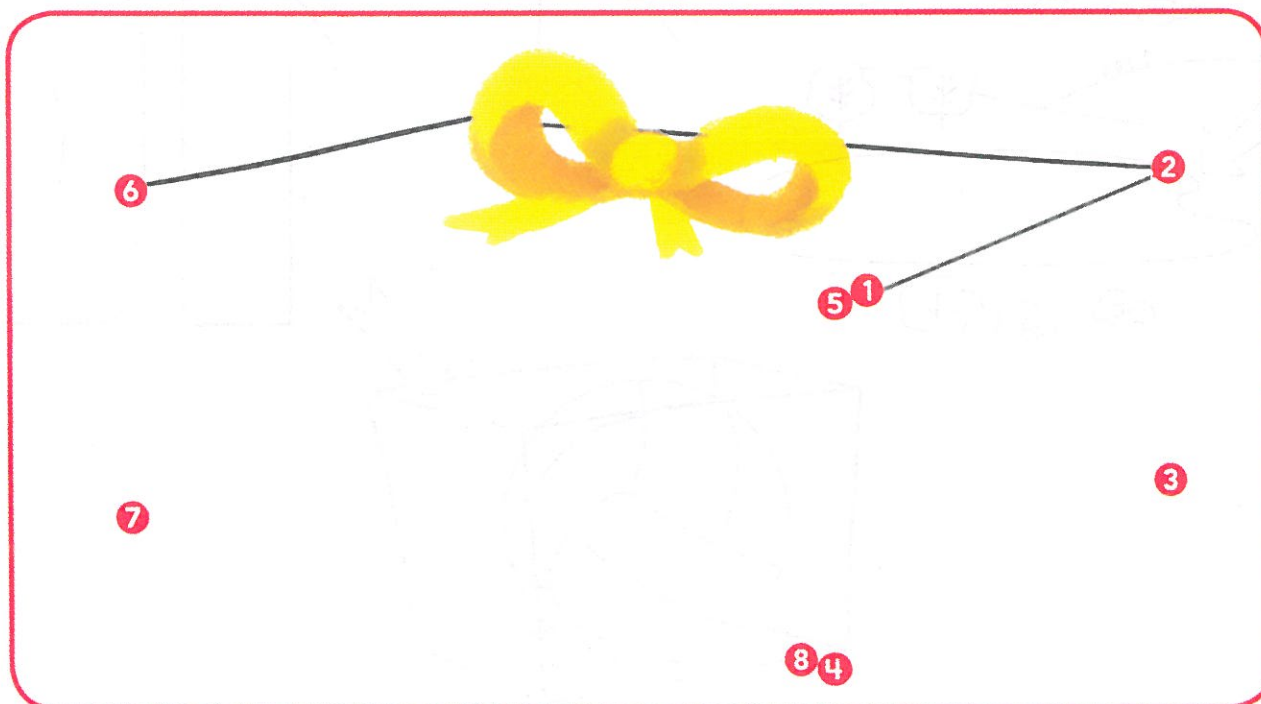



1:65  
15

Listen and ✓.

1 a

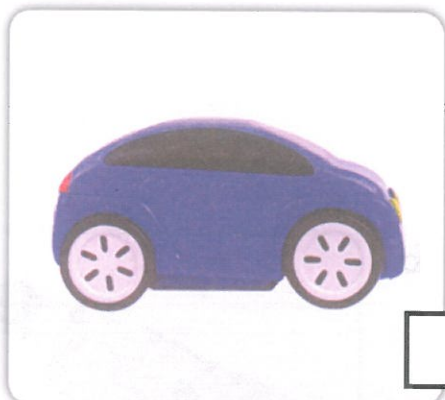

b

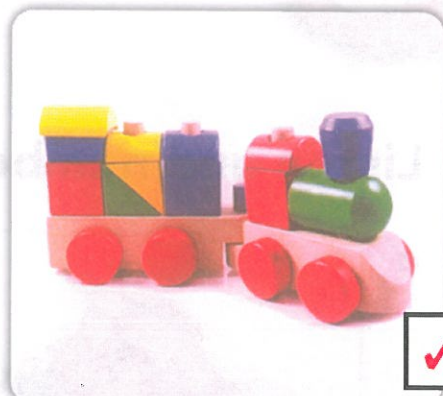

2 a



b



3 a



b

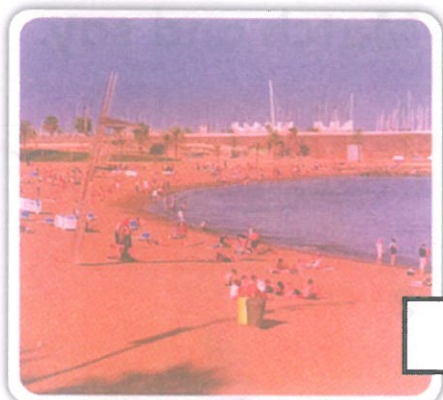

4 a



b



# unit 3

# I like cake!



1 Listen and number.

a



b



c



d



1



2 Match and say.

1



2



3



4



d





Listen and circle. Sing. 🎵

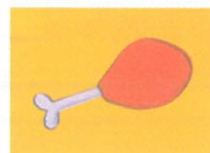
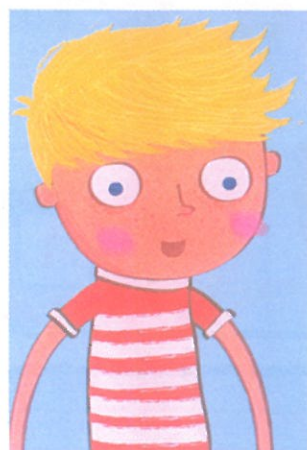
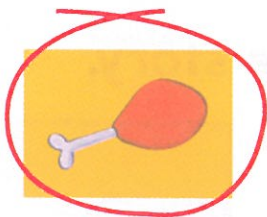

**THINK  
BIG**

Look and ✗ the odd one out.

1







2









## 4 Number in order. Tell the story.





1:76  
**5**

**Listen and match.**

Listen and draw  
**6**

1



2

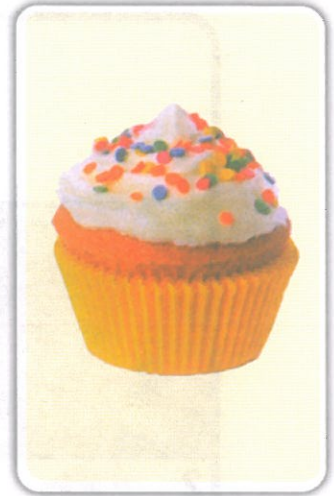

3



4



5

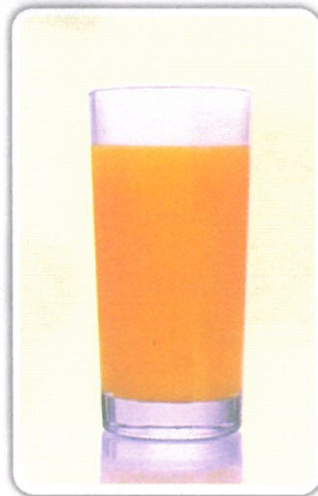















6



1:78  
6

Listen and draw.

listen and match

				
1 				
2 				

7

Look and ✓ or ✗ for you. Say.

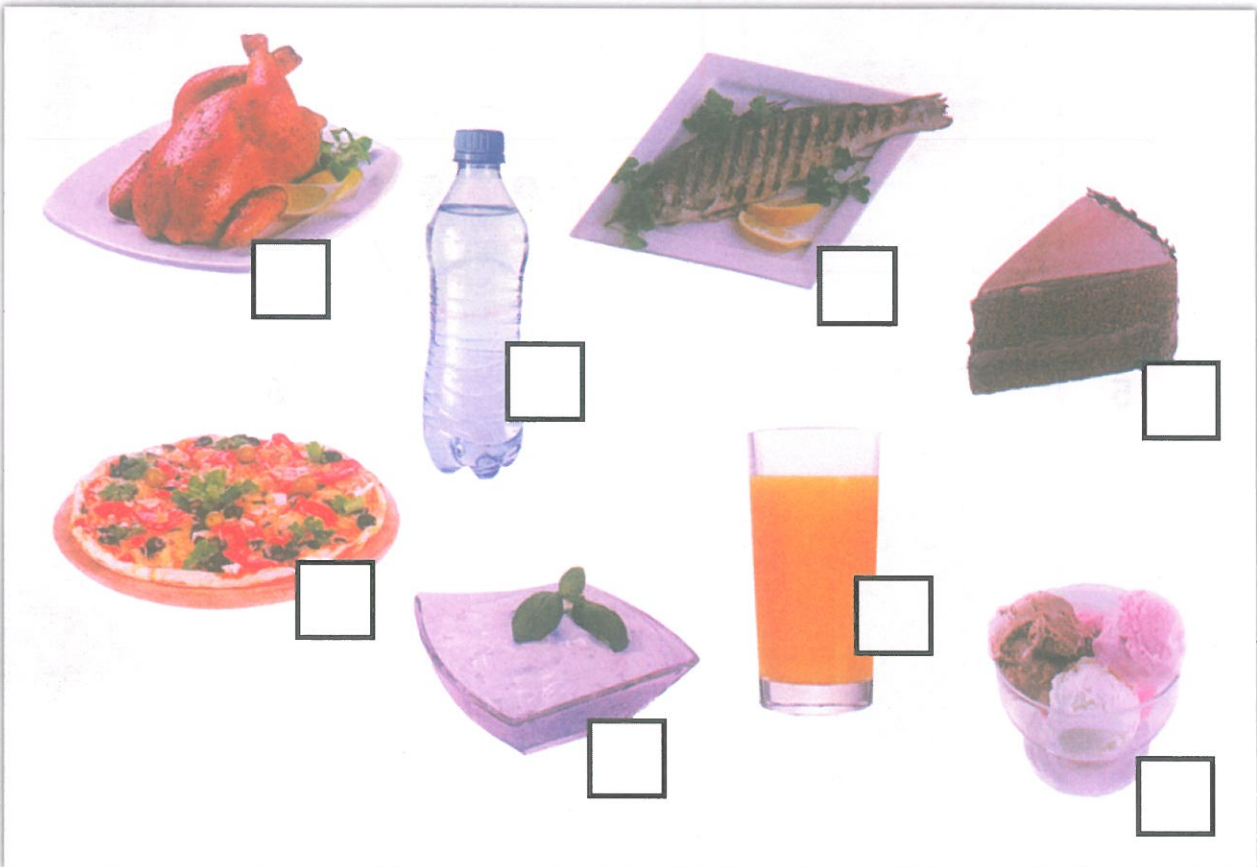



8 Look and colour. Say.



=



2



=



4



1



3

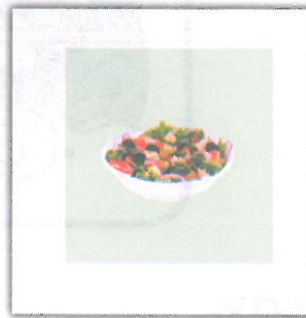

**THINK BIG**

Look, match and say.

1



3



2



4



1:01  
9

Listen and number.

a

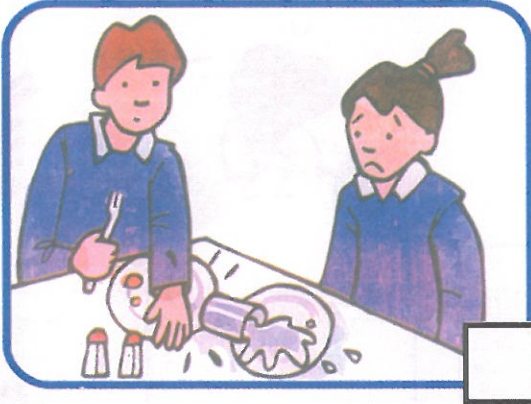

b

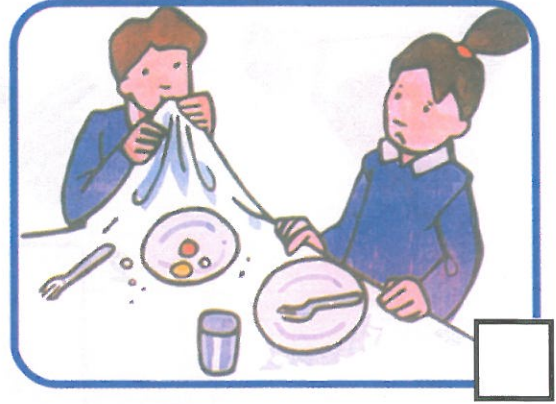

c

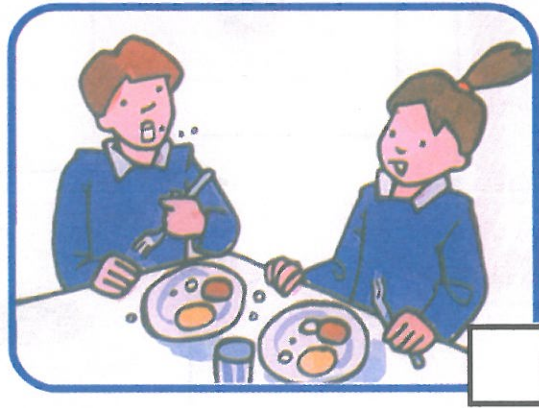

10

Draw and say.

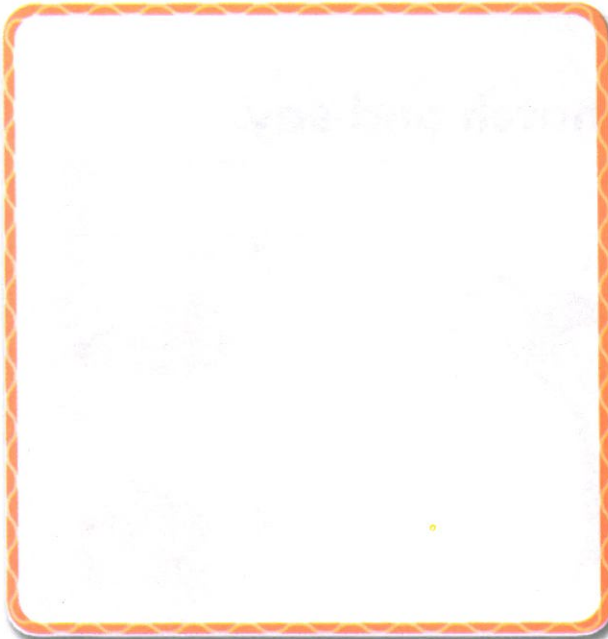



11 Look and match.

Colour and find.



## 12 Colour and find.

1

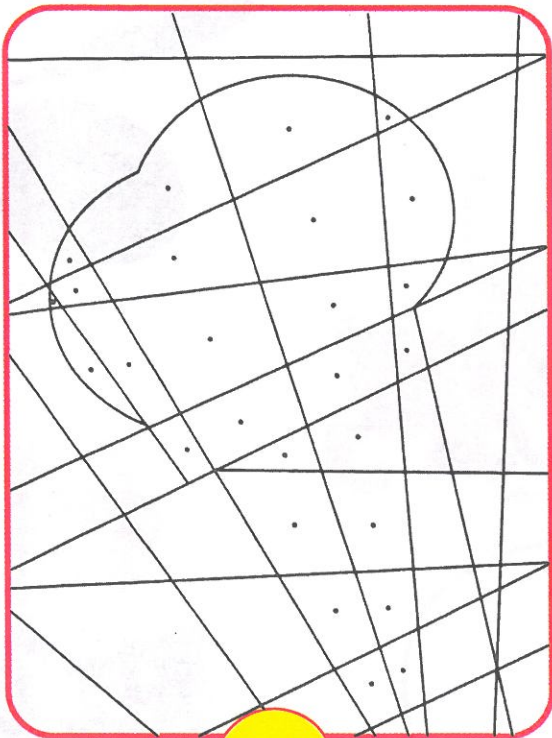

2

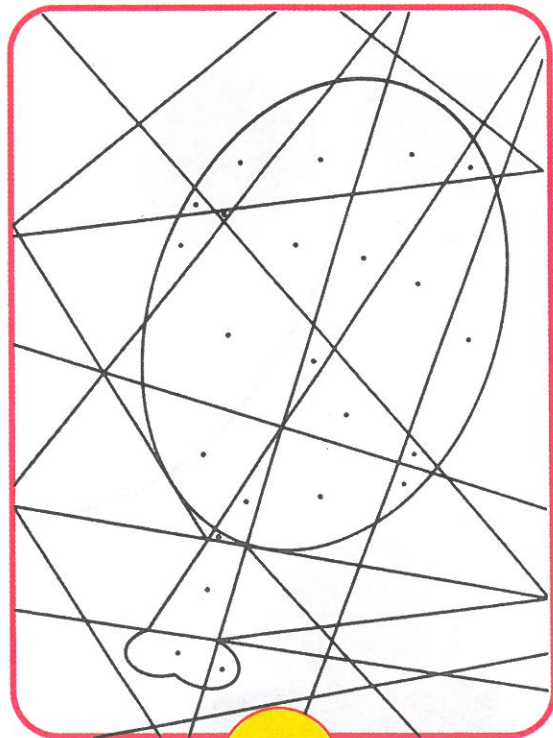

3

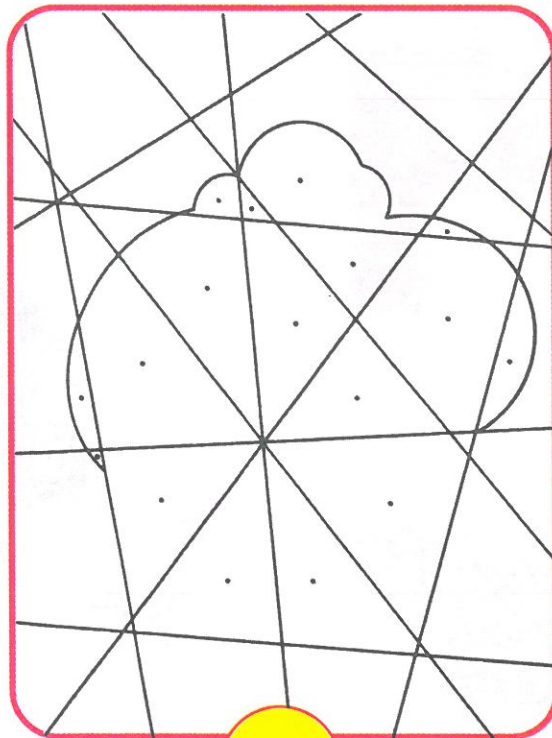

4

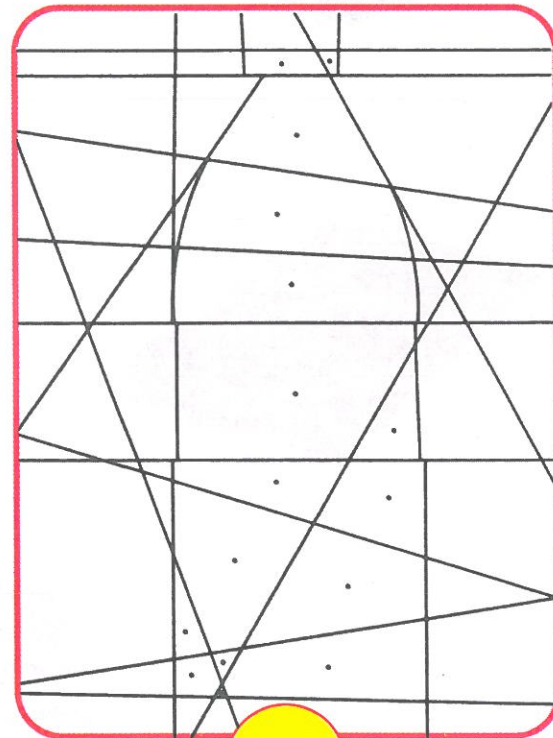





Listen and ✓ or ✗.

1



2

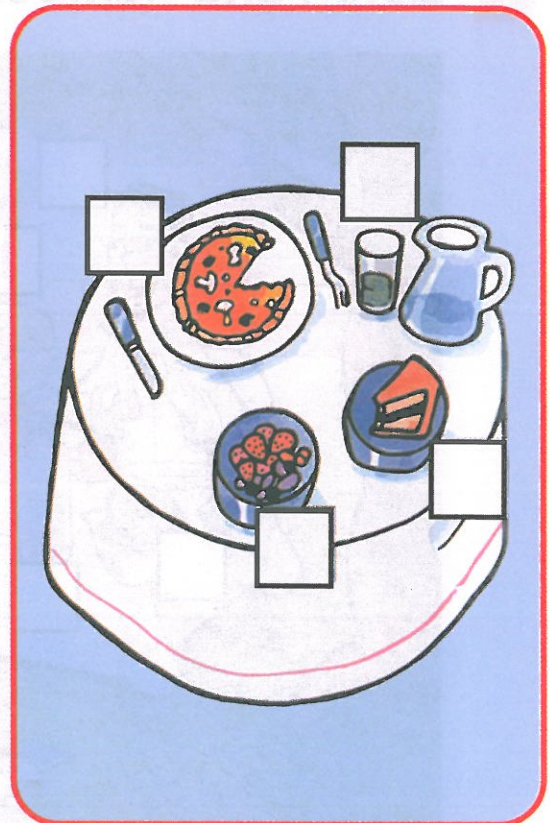

3

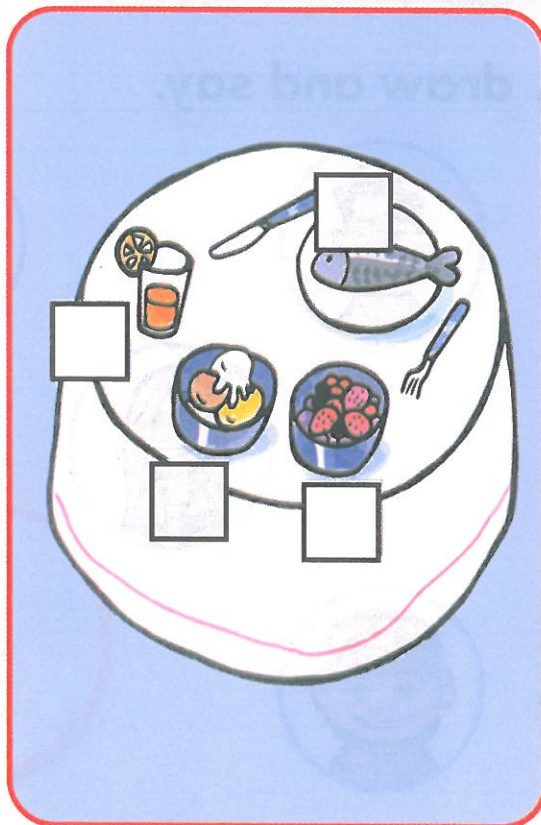

4

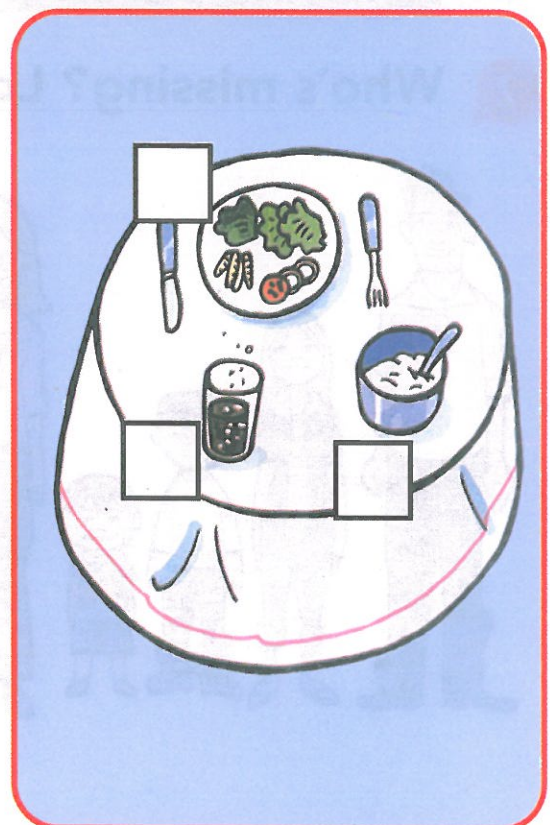



Think Big



1 Listen and number.

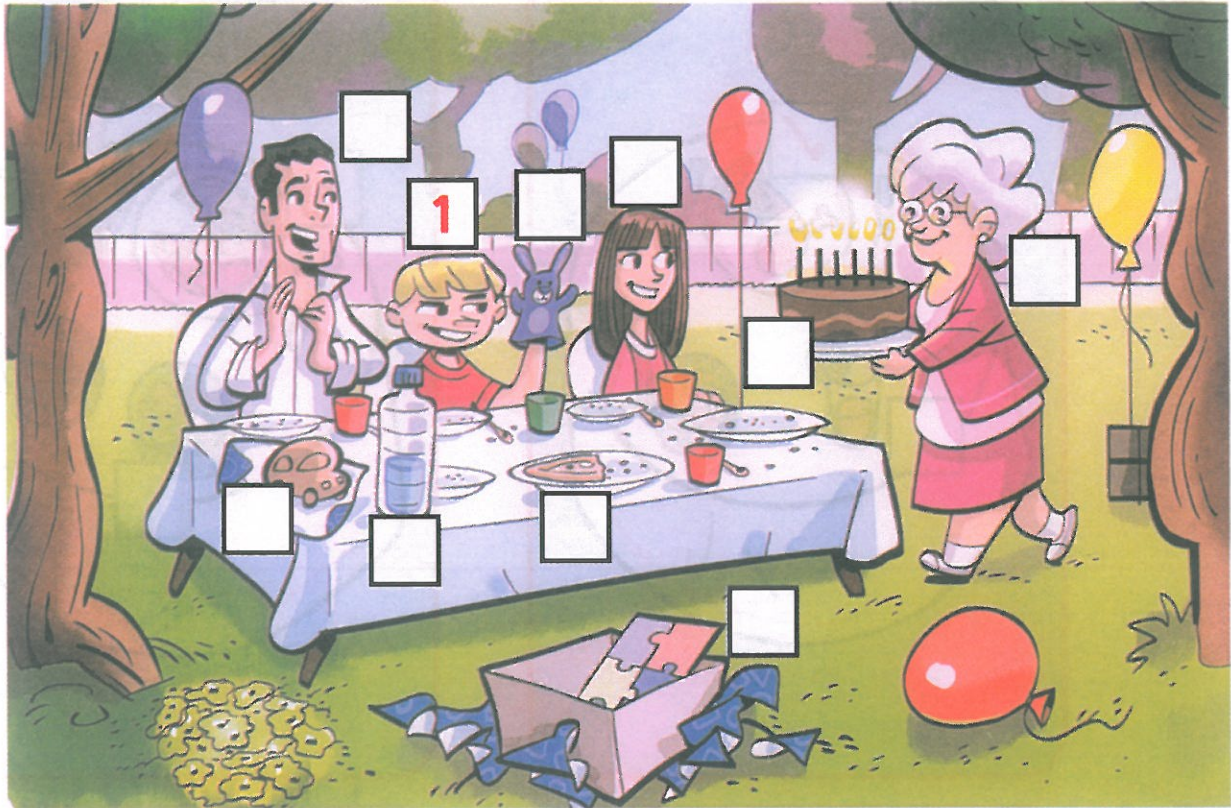

2 Who's missing? Look, draw and say.

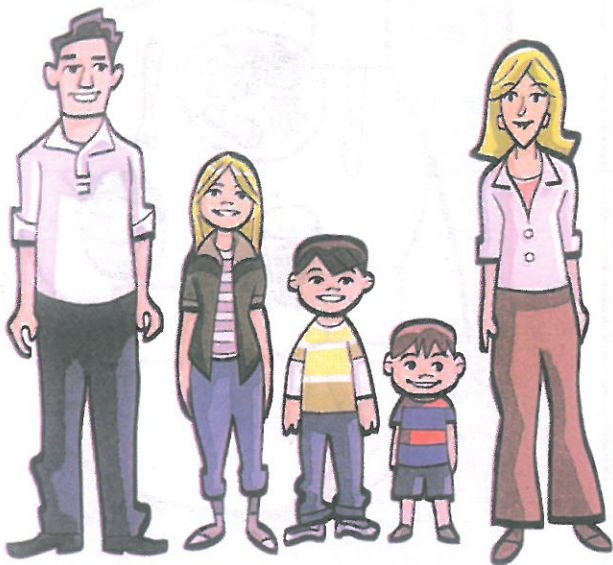



2:04  
3

Listen and colour.

1 a

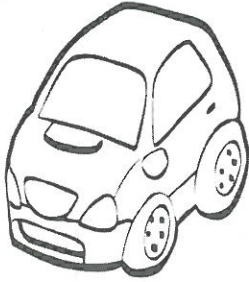

b

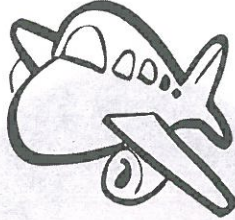

2 a

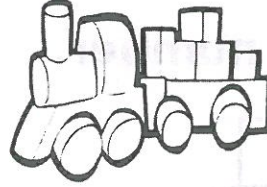

b

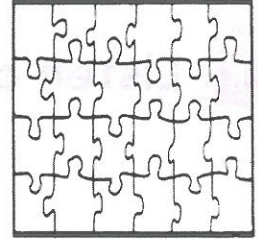

3 a

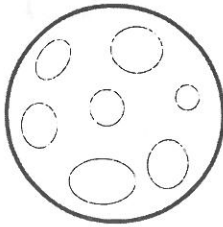

b



4 a



b



4

Look and match for you.

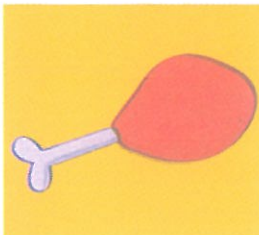

unit  
4

# My Body



Listen and number.



2 Complete and say.

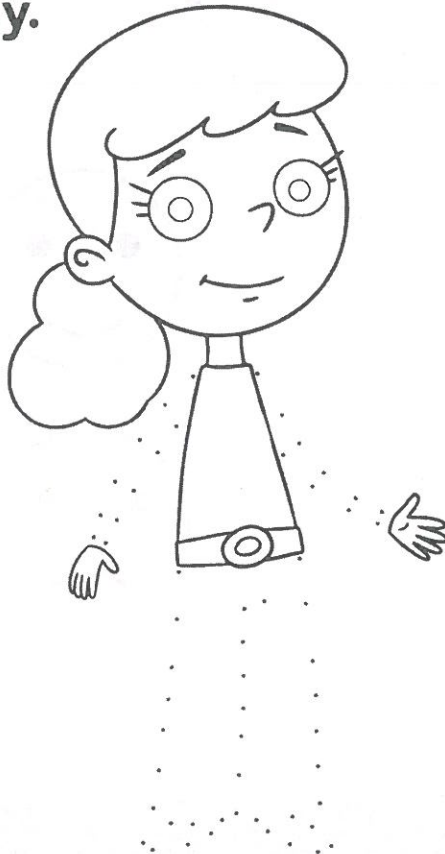





Listen and draw. Sing. 🎵

1

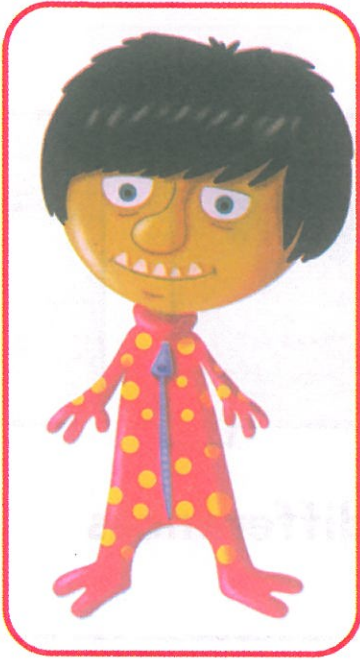

2



3



**THINK  
BIG**

Count and write. Say.







4 Listen and number.

a

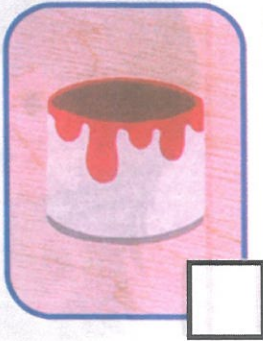

b

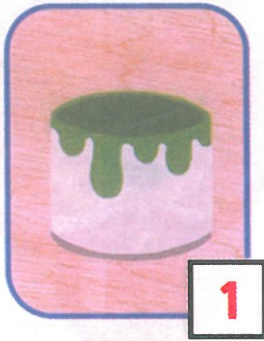

c

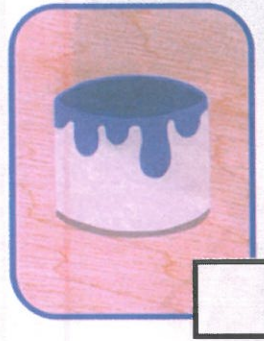

d

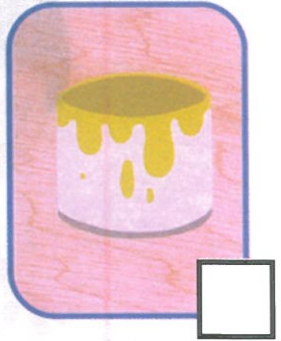

5 Look at 4 and colour. Say 2 differences from the story.





2:16  
6

Listen and circle.

1 a

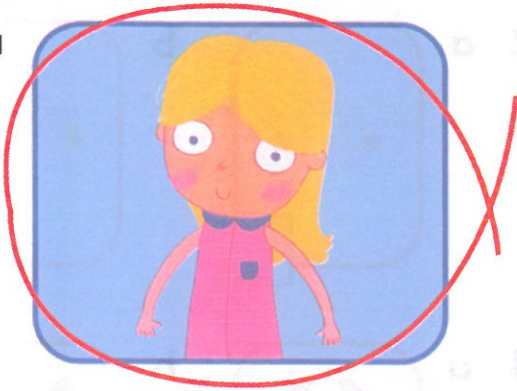

b



2 a

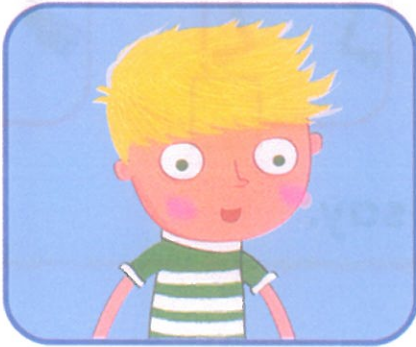

b

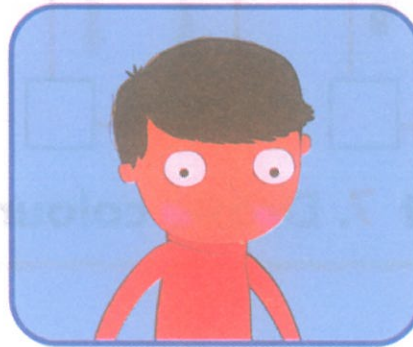

3 a

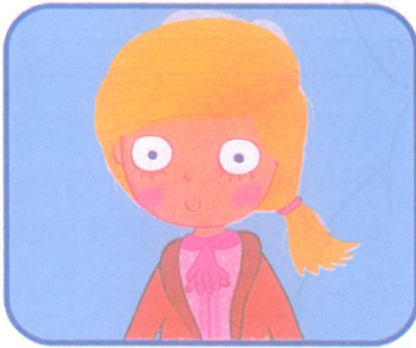

b

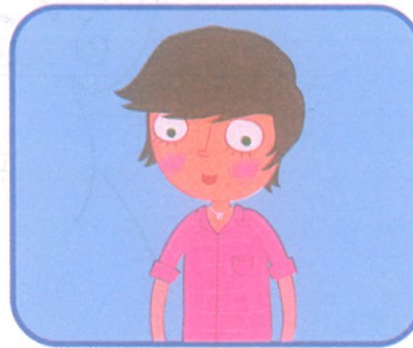

4 a

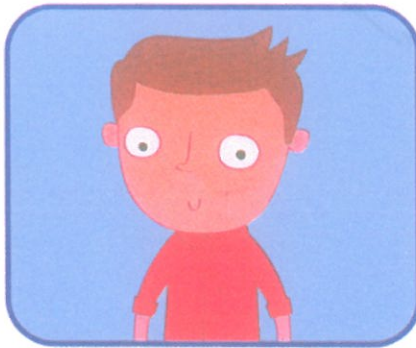

b

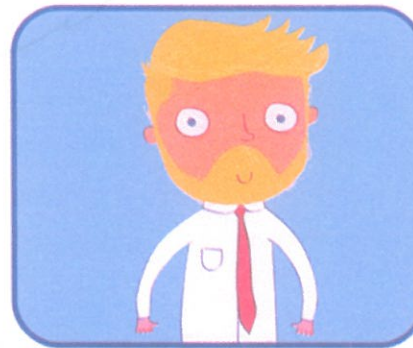



**7 Listen and ✓.**

1 a

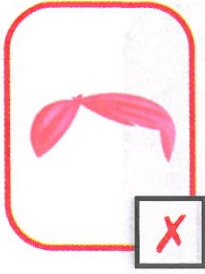

b

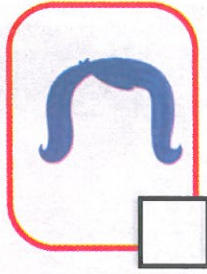

2 a



b

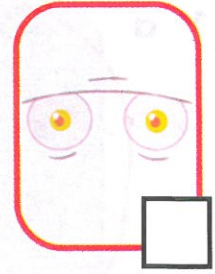

3 a

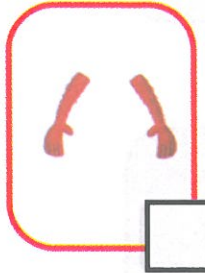

b

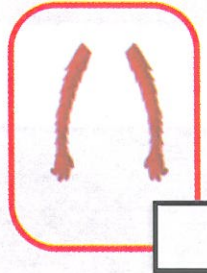

4 a

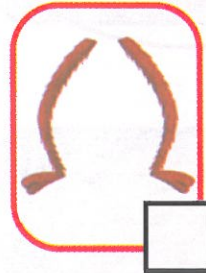

b

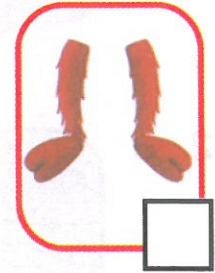

**8 Look at 7. Draw, colour and say.**

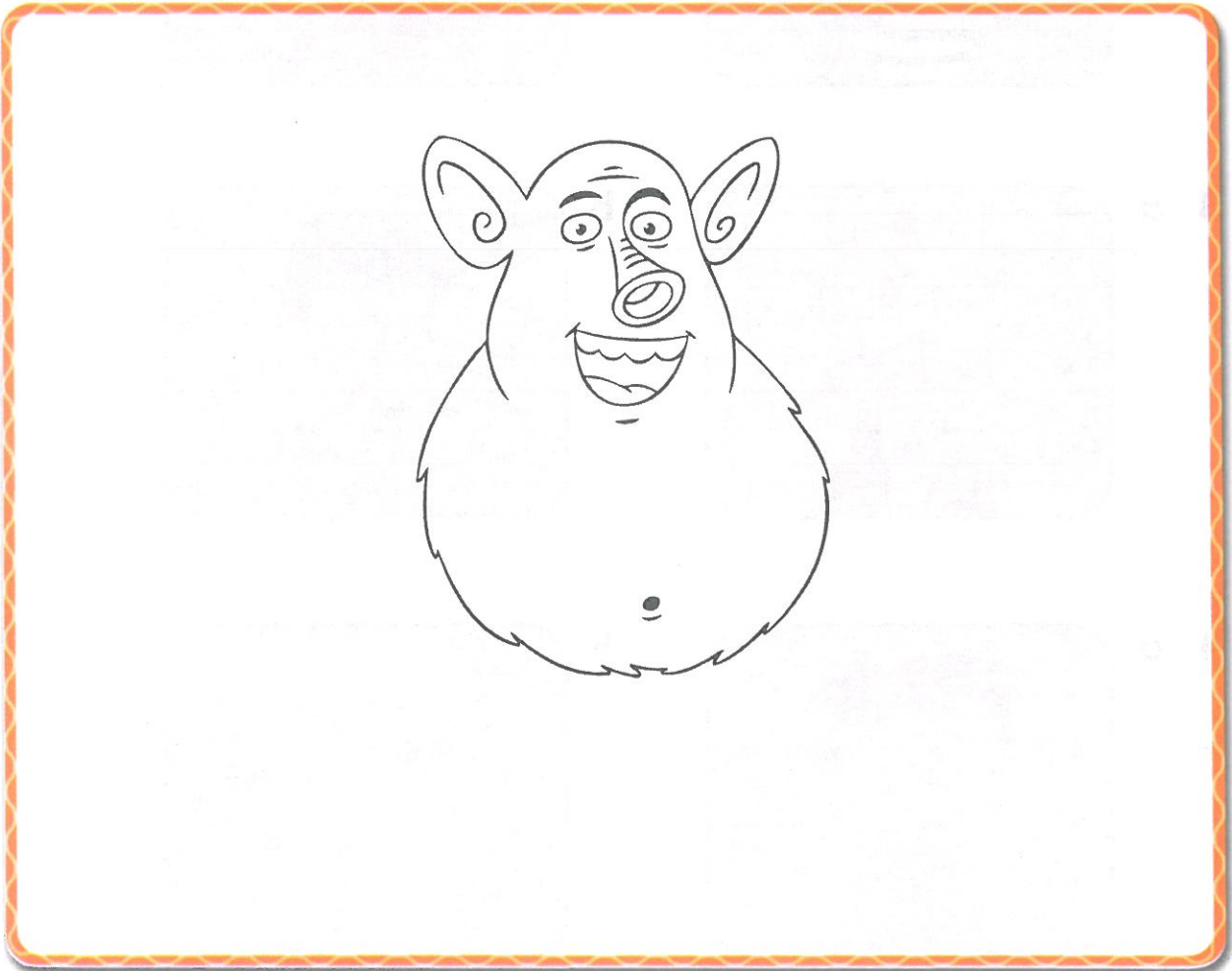





Listen and ✓ or ✗.

1



2



3



4



**THINK BIG**

Look and draw 😊 or ☹️.

1

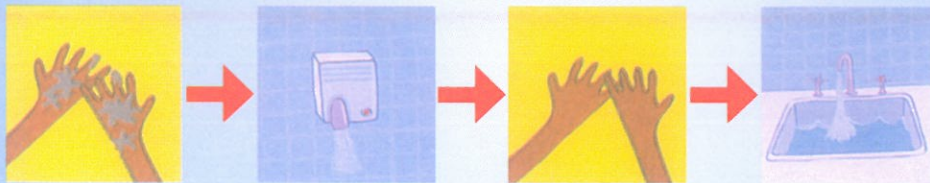

2

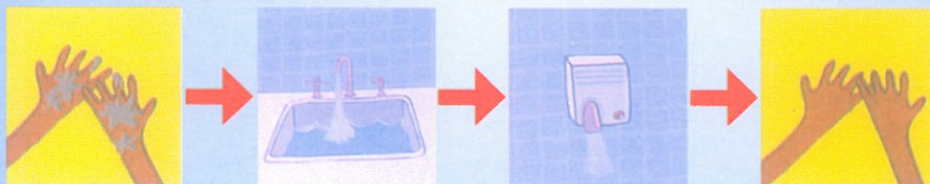

10 Count and draw. Say.

1

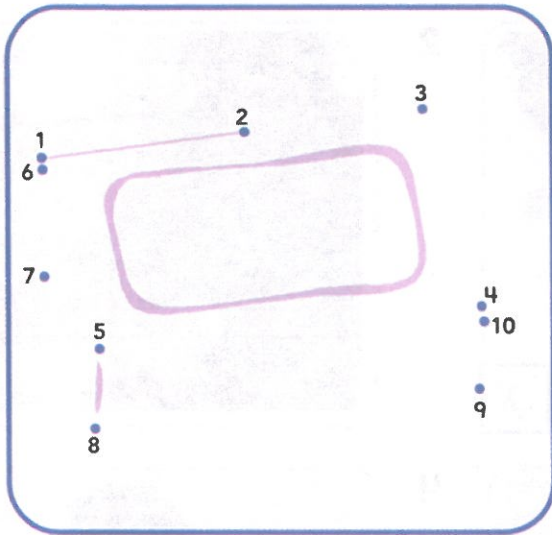

2

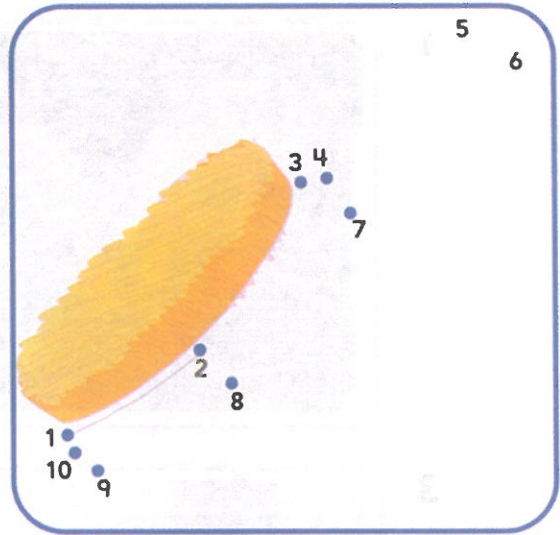

3

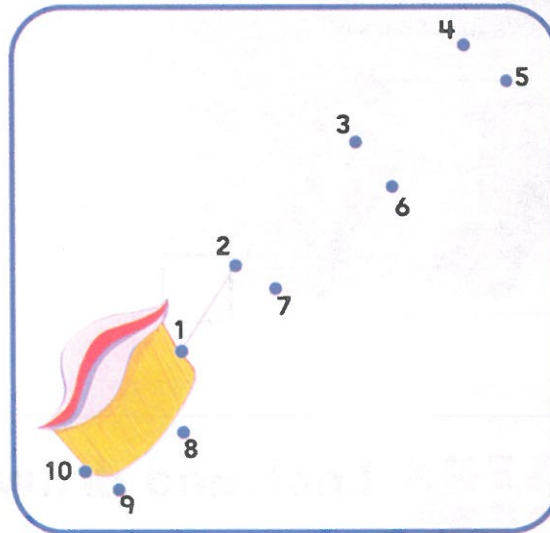

11 Draw and say.





12 Find and colour. Say.

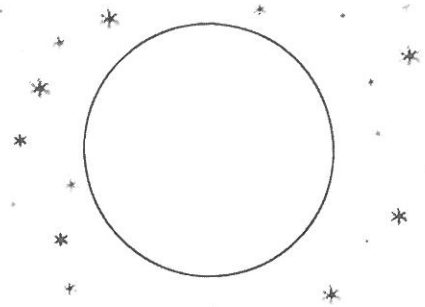
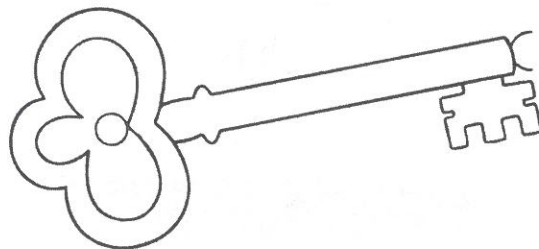
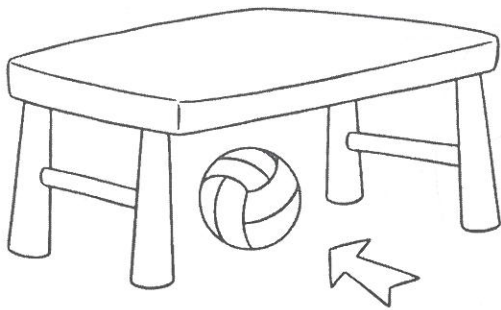
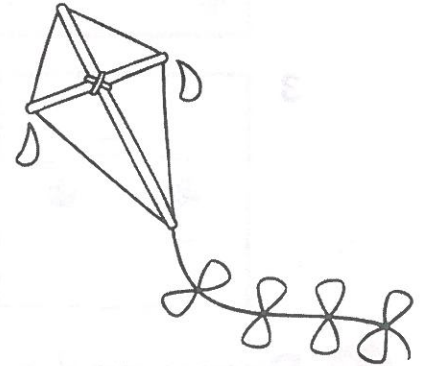
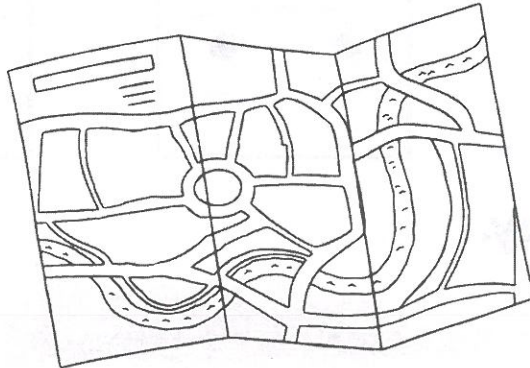
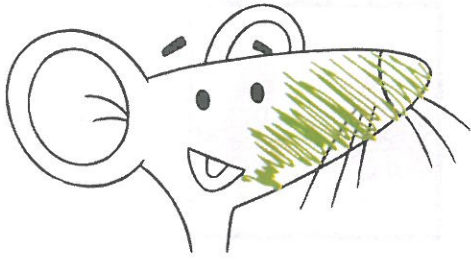

13 Look and circle the odd one out.

1



2

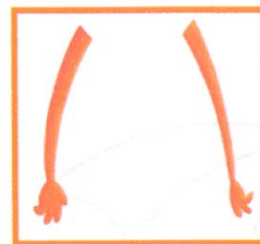
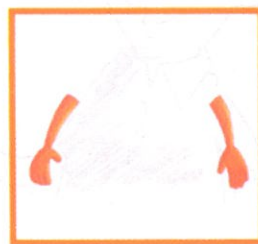
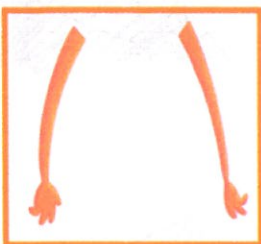

3

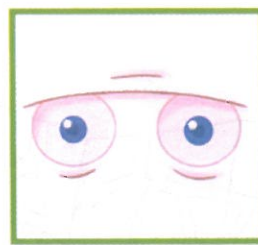
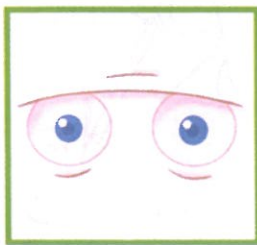

14 Draw and say.

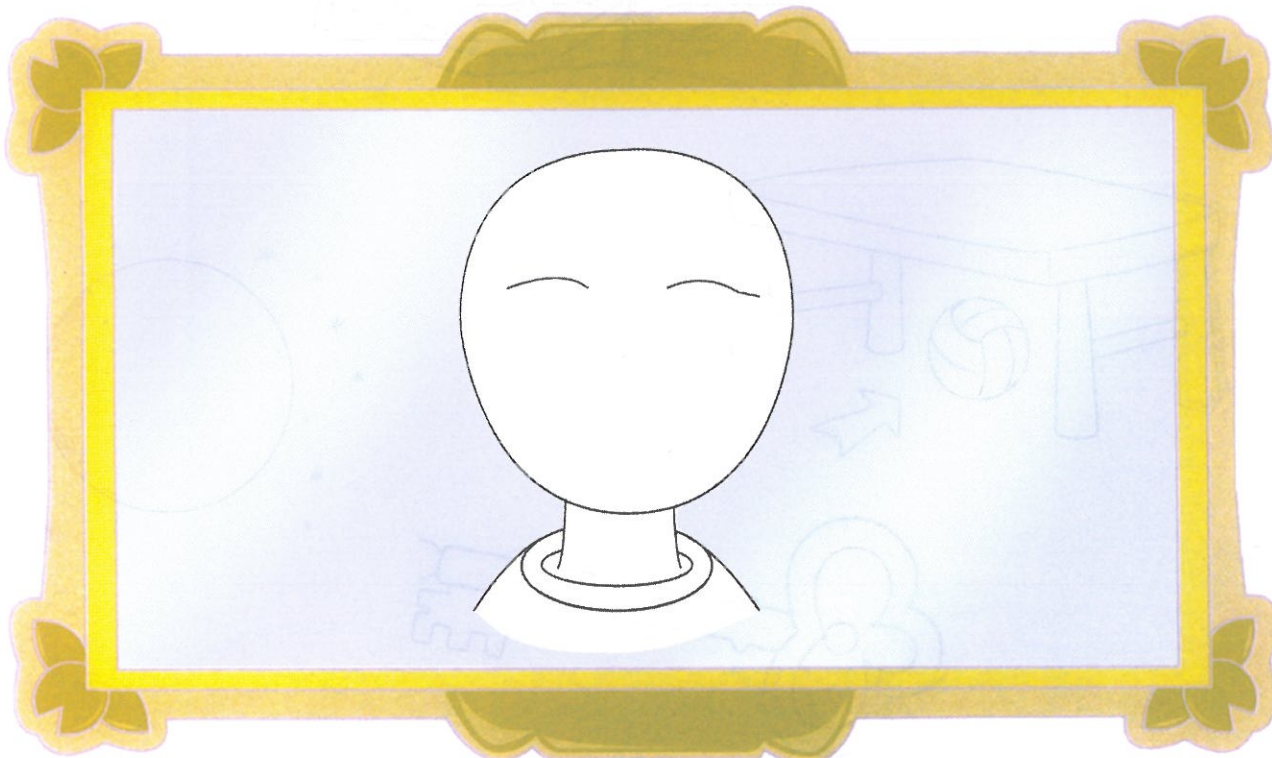



2:28  
15

Listen and match.

- 1
- 2
- 3
- 4
- 5
- 6

a



b



c



d



e



f

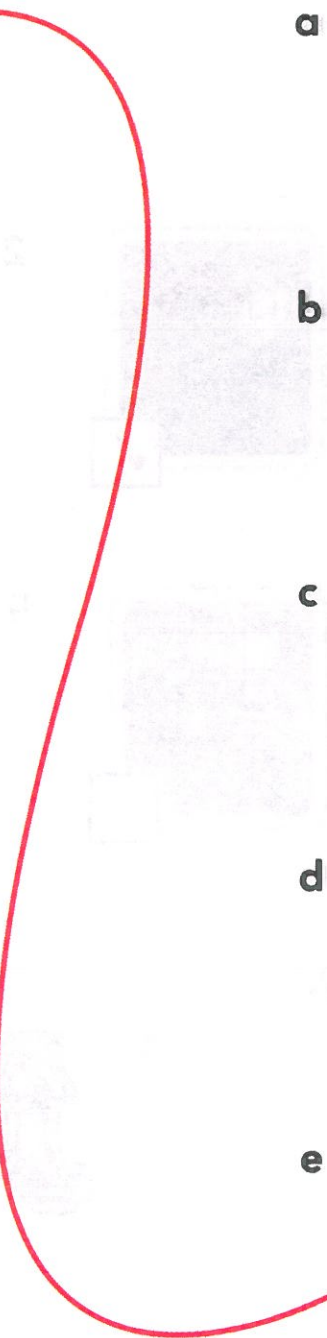

# unit 5

# Around Town



Listen and ✓.

1 a



b



2 a



b



3 a



b



4 a



b



Match and say.

1



2



3



a



b



c





3

Listen and number in order. Sing.

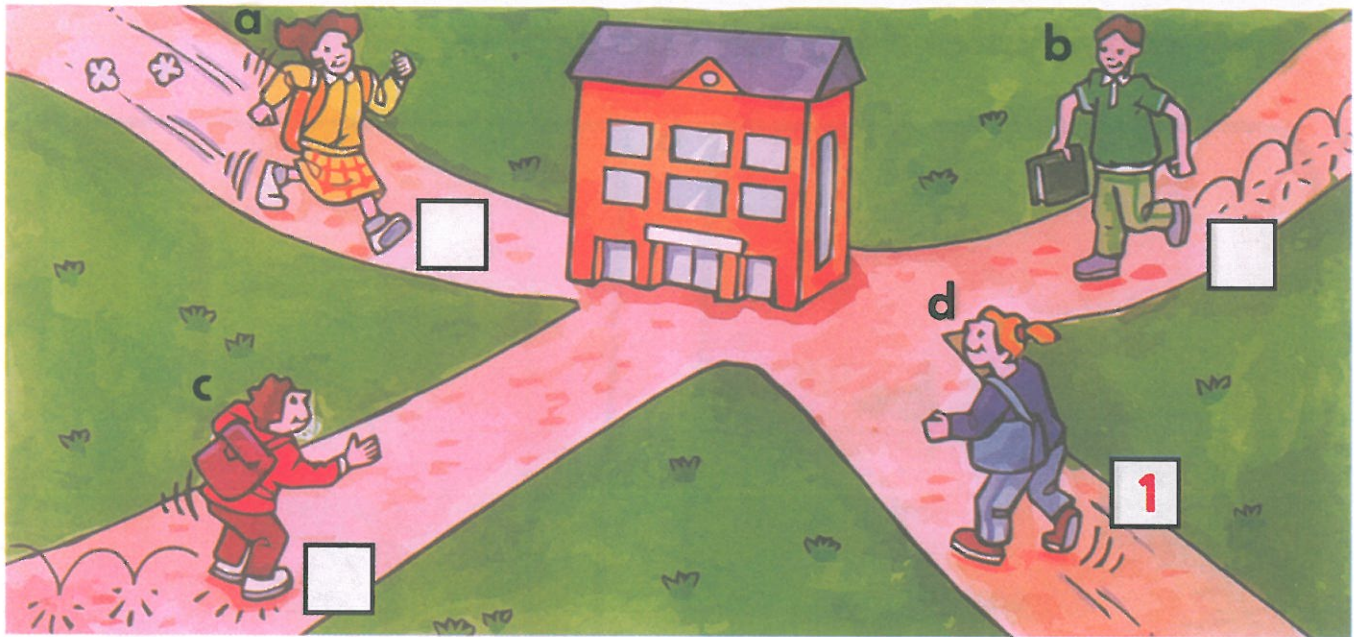

**THINK BIG**

Look and draw. Say.

1



2





## 4 Number in order. Tell the story.





8 Complete and say.

1

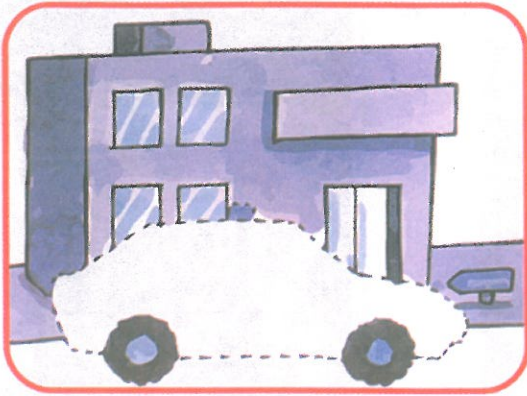

2

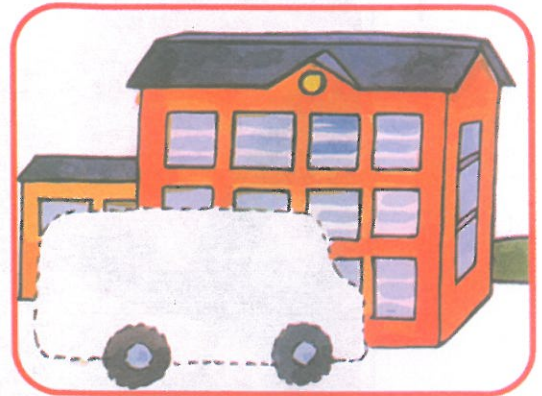

3

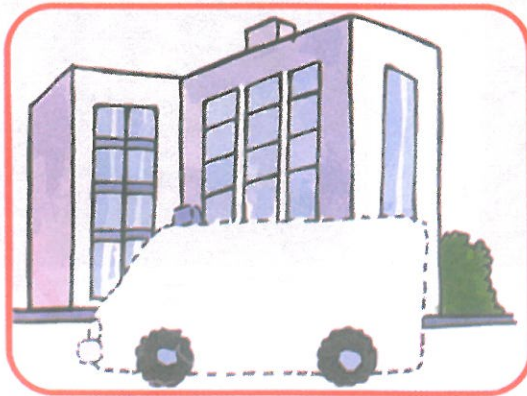

4

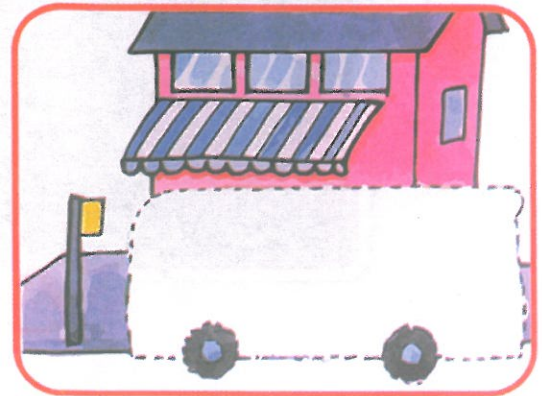

**THINK BIG** Look and ✓ or ✗.

1



2



3





9 Look and circle. Say.

1



2



3



4

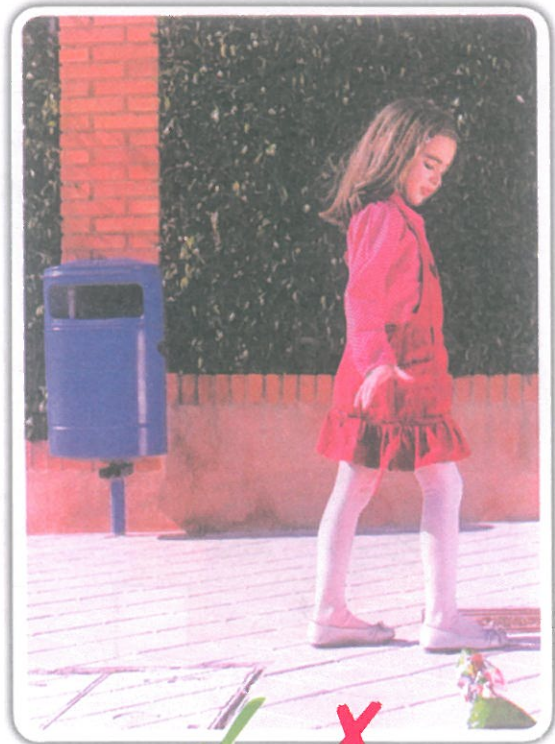



10 Look and match.













Look. Match and say.



# Review

11 Look. Match and say.

Look and match

1



2



3



4



a



b



c



d









2:49  
12





Listen and circle.

1

a  b  c  d 

A blue line connects image b to image c.

2

a  b  c  d 

A blue line connects image b to image c.

3

a  b  c  d 

A blue line connects image b to image c.

4

a  b  c  d 

A blue line connects image b to image c.

unit  
6

# She's swinging on the swings!



Listen and colour.

a



b

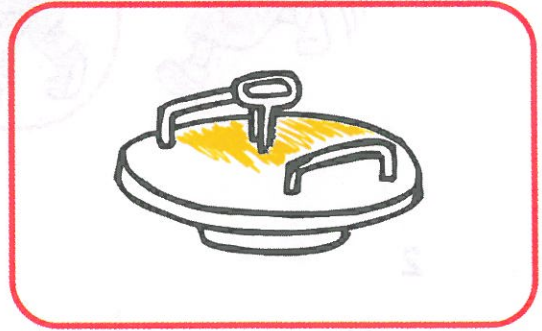

c

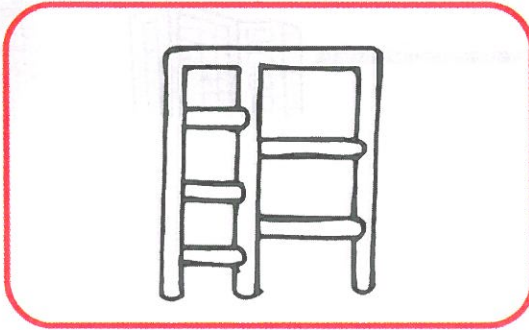

d

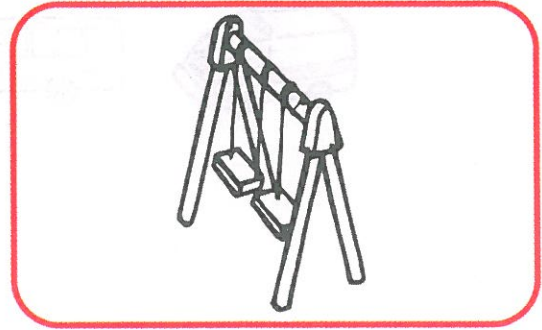

Complete and say.

1



2



3



4





Look and match. Listen, number and sing. 🎵

a



b



c



d

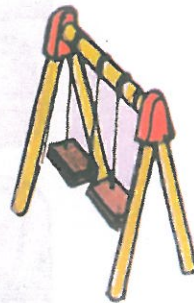
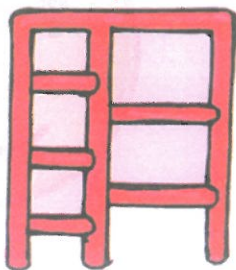

**THINK  
BIG**

Look and number. Say.

1



2



3



a



b



c



## 4 Look and match. Say.

1



2



3



4



5







5 Listen and number.

Listen and number.

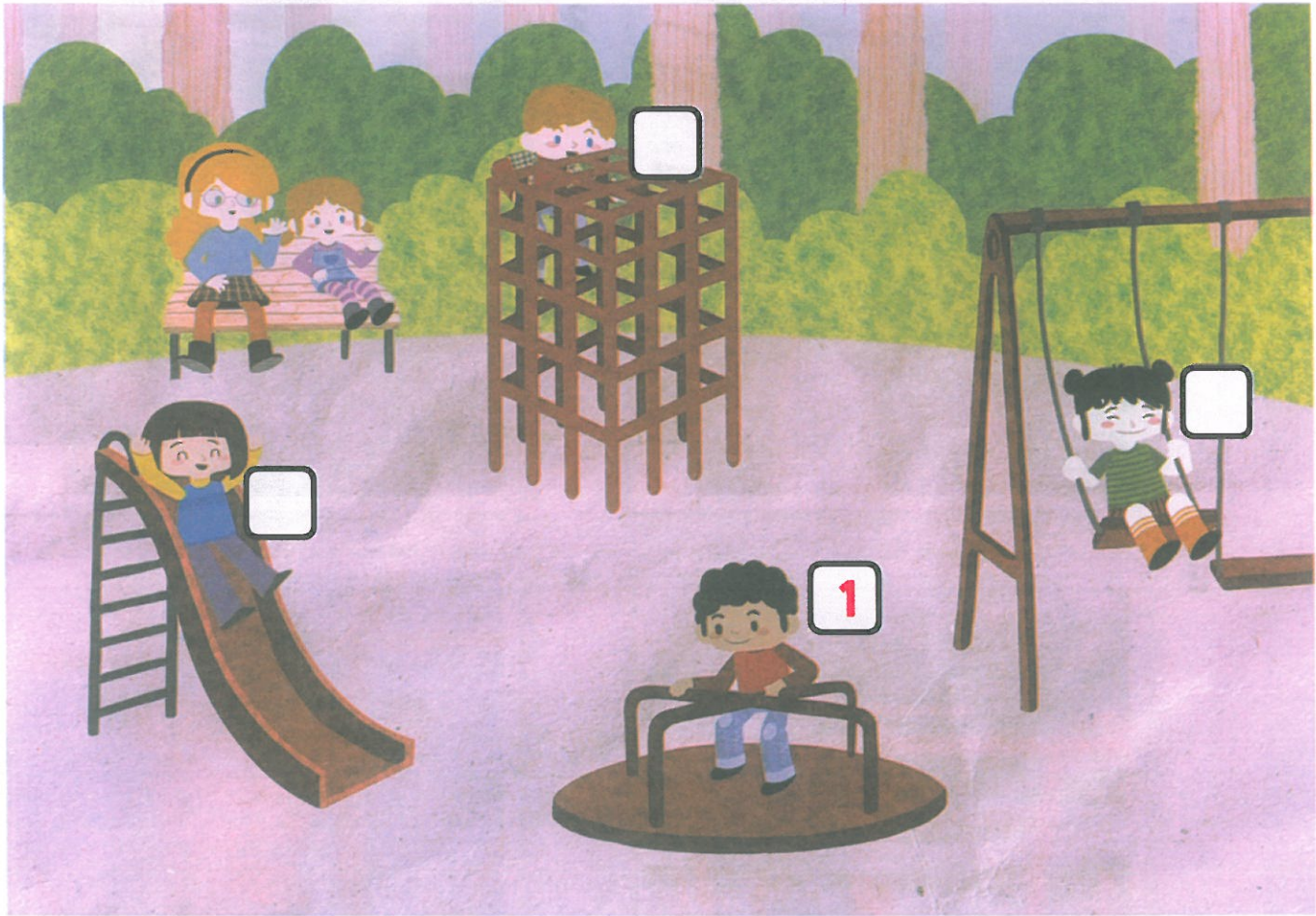

6 Draw and say.

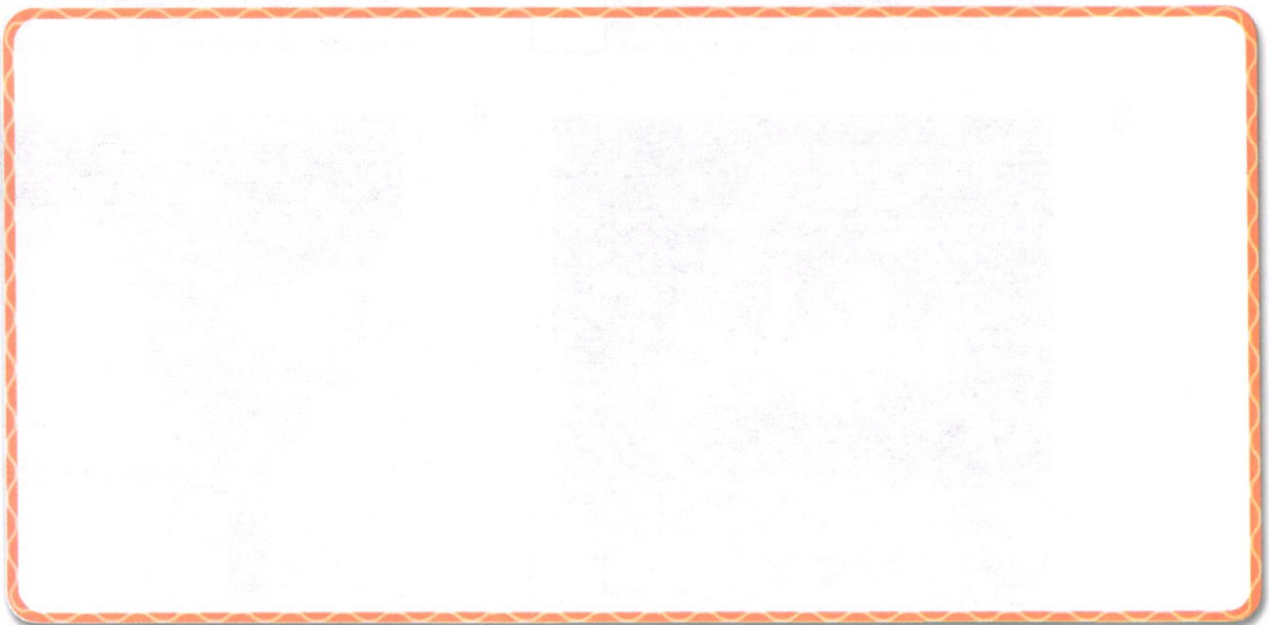





Listen and ✓ or ✗.

1



2



3



4

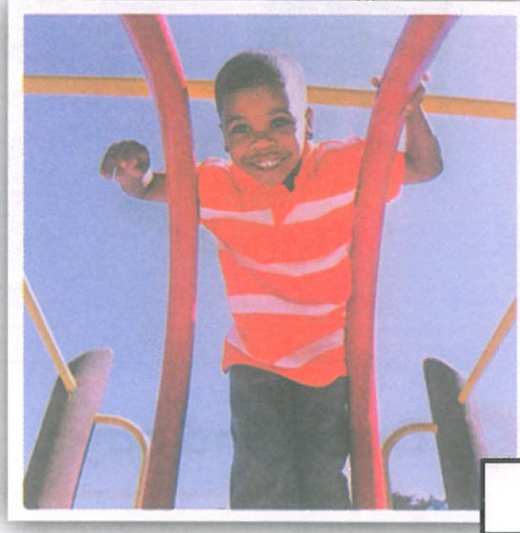

5



6

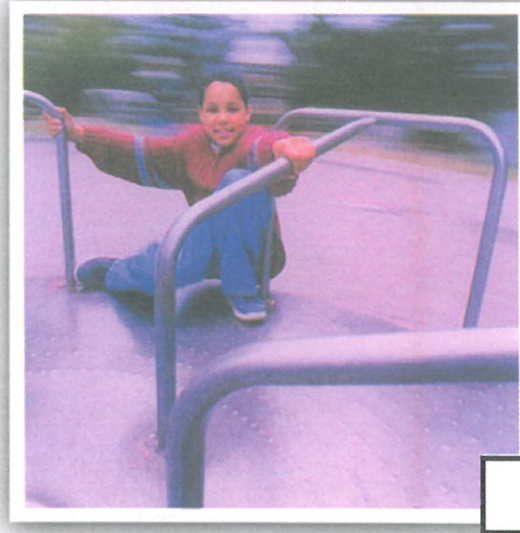



8 Number in order. Say.

a

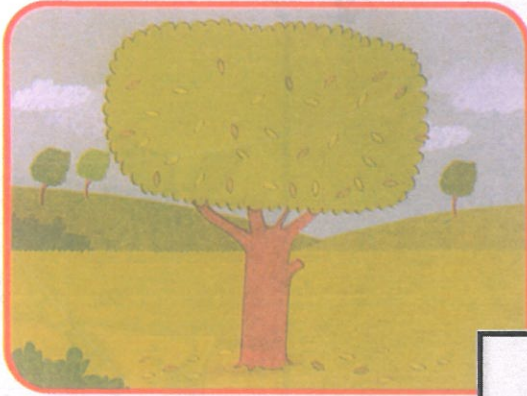

b

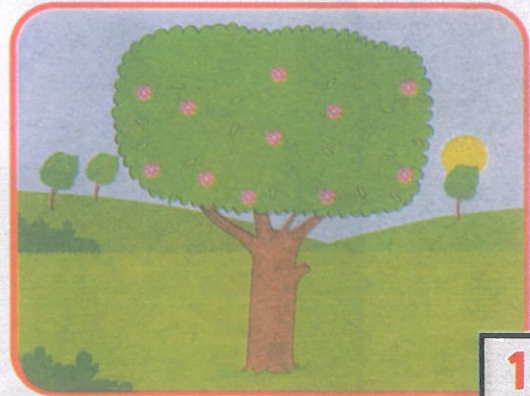

c





d

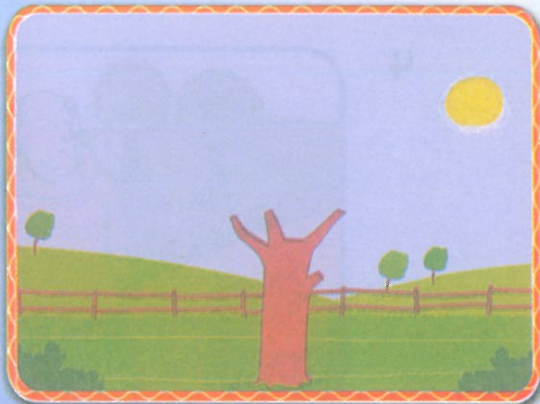

**THINK BIG** Look and draw.

1



2





9 Look and match. Say.

1



2



3



4







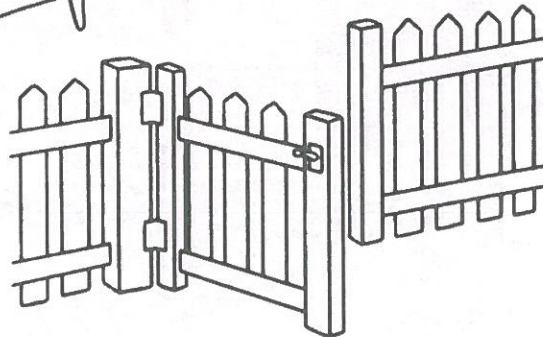
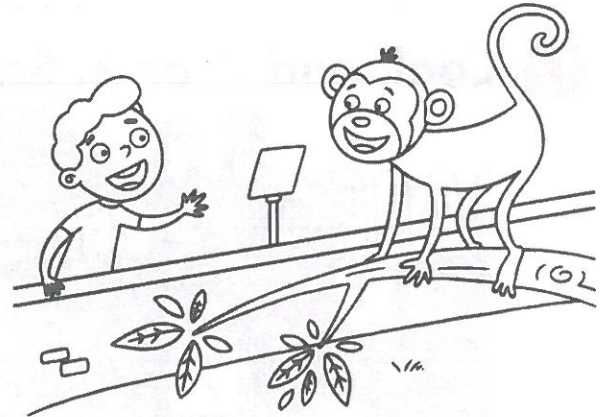
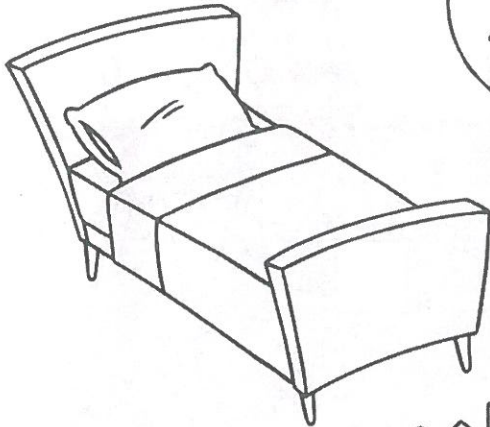
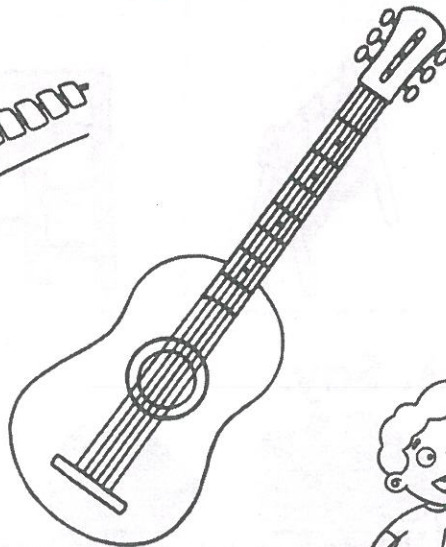
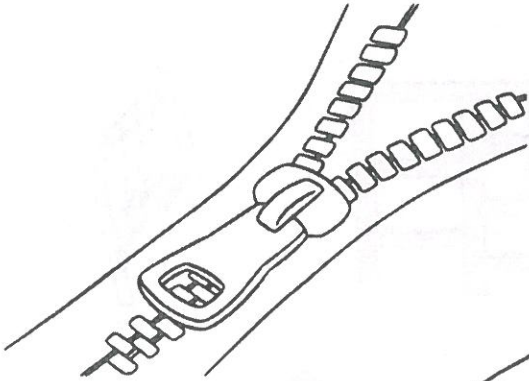
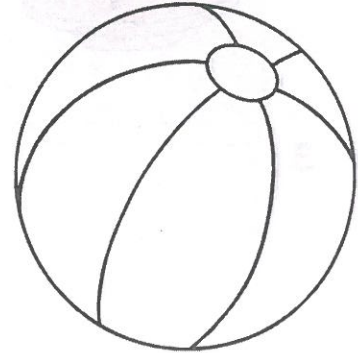



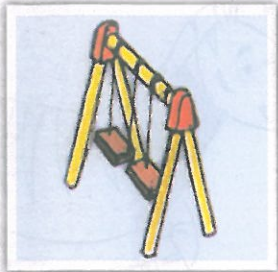

10 Find and colour. Say.

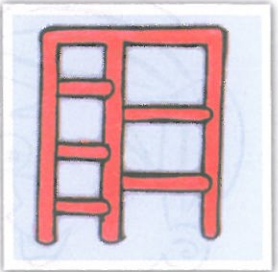

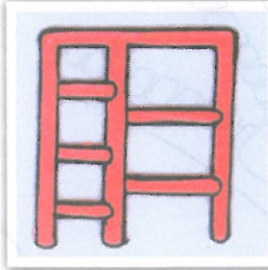
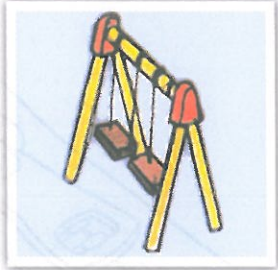

## 11 Look and draw. Say.

1				
2				
3				

## 12 Look and ✓ or ✗. Say.

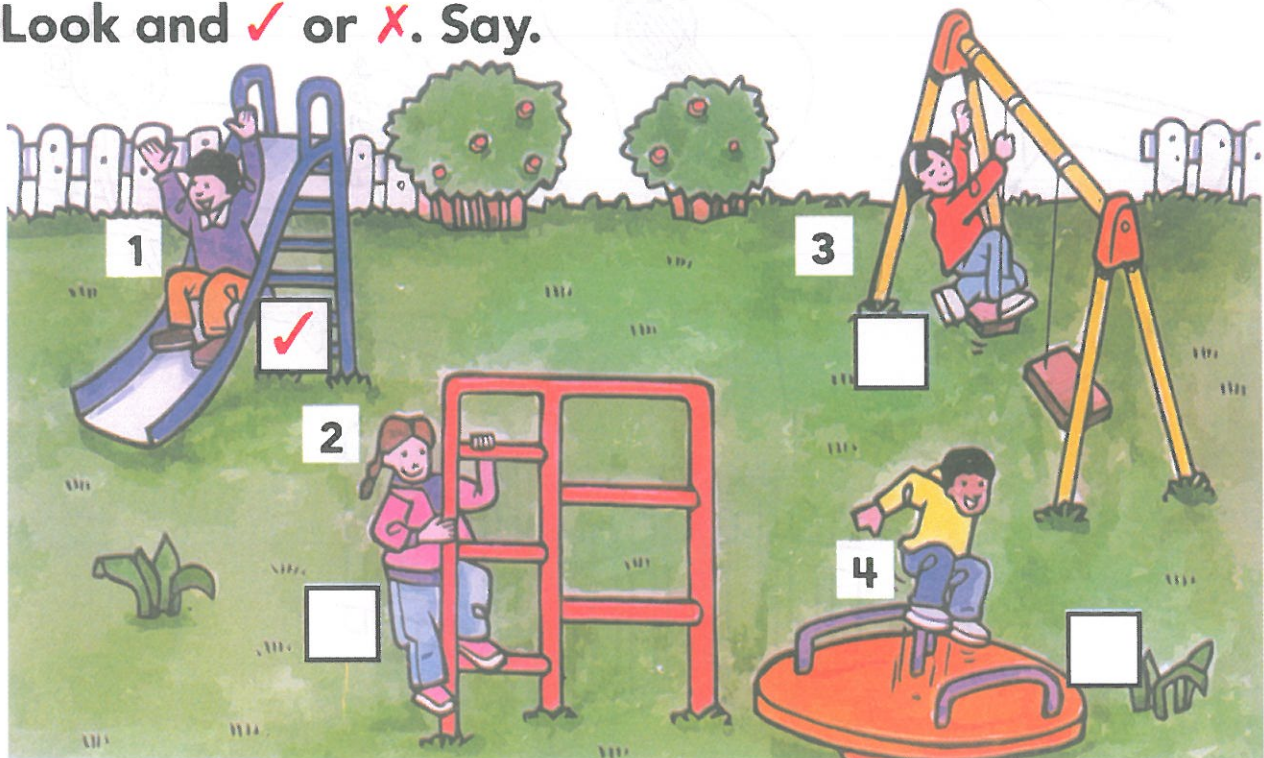



2:58  
13

Listen and circle.

1 a



b



2 a



b



3 a



b



4 a



b



5 a



b



6 a



b





Think Big



Listen and number.

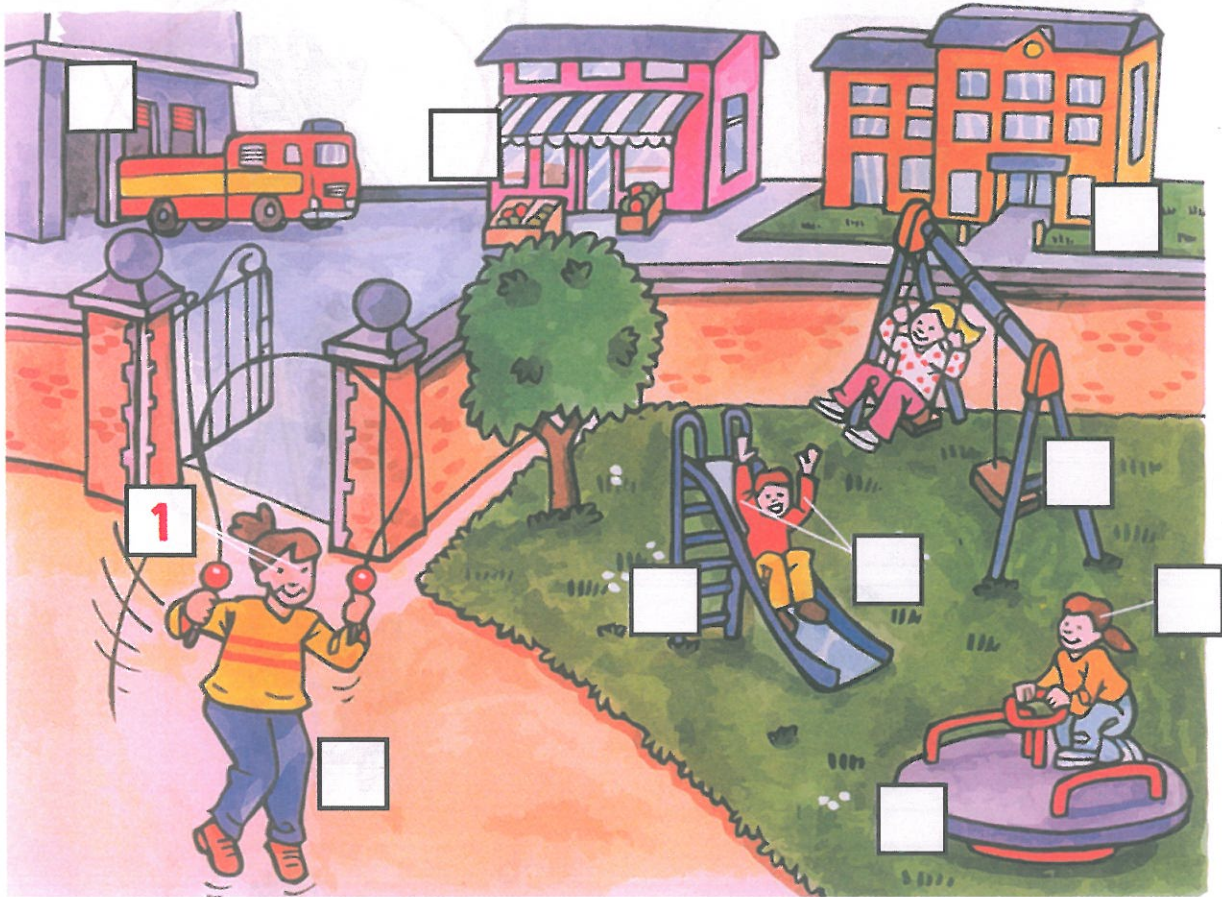

Look and draw. Say.

1



2





2:72  
2

Listen and match.

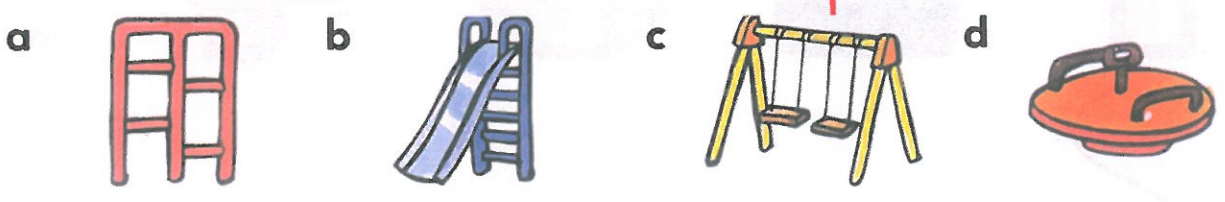
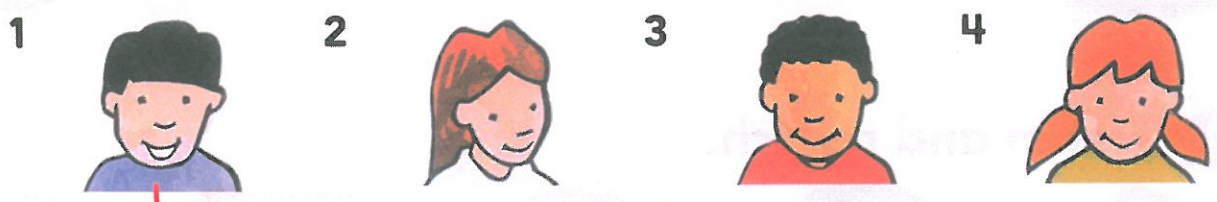

4 Look and ✓. Draw and say.

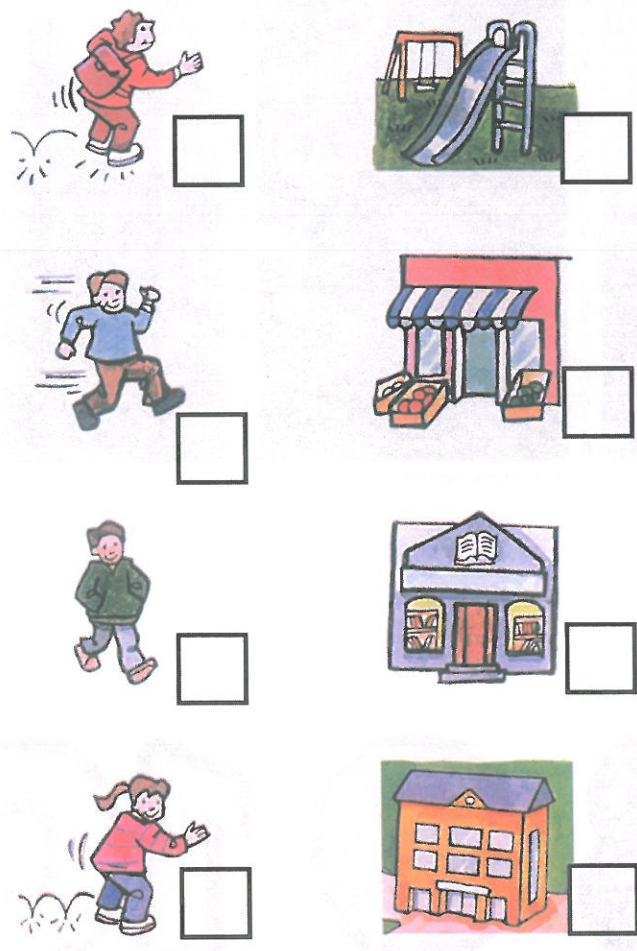

unit  
7

# It's sunny!

3:03  
1 Listen and match.

1

2

3

4

5

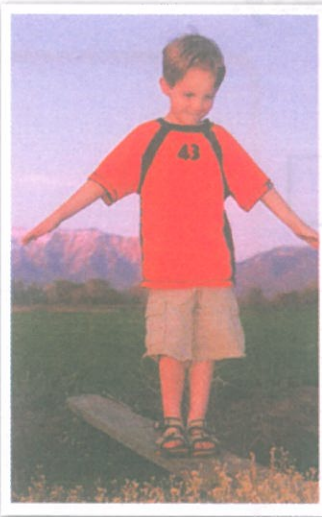

6

7

8

9

10



Listen and draw. Sing. 🎵

1

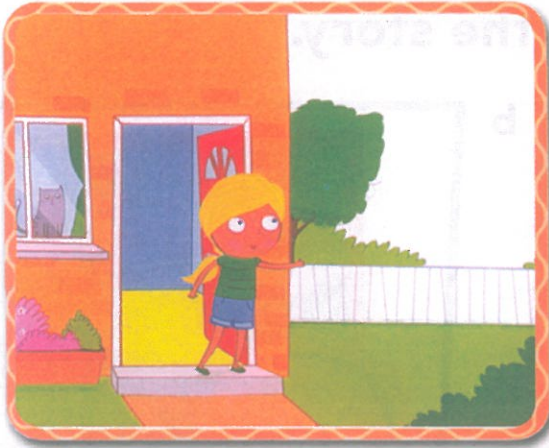

2

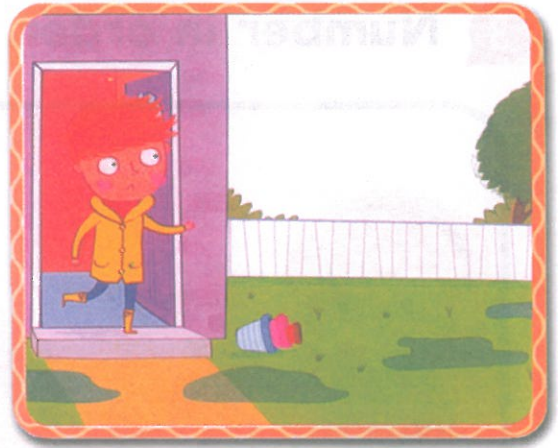

3

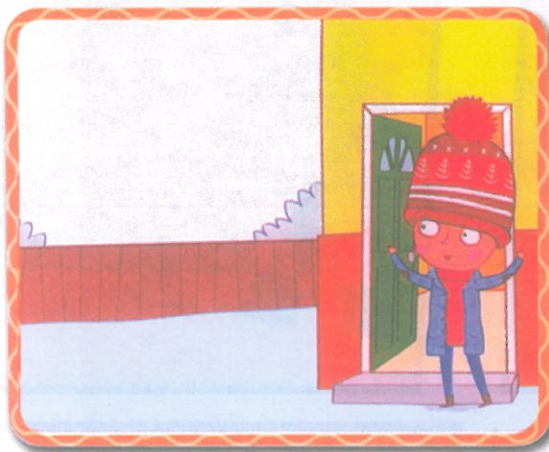

4



**THINK  
BIG**

Look and circle. Say.

1



a



b



2



a



b





## 3 Number in order. Tell the story.







4 Listen and ✓ or X.

1

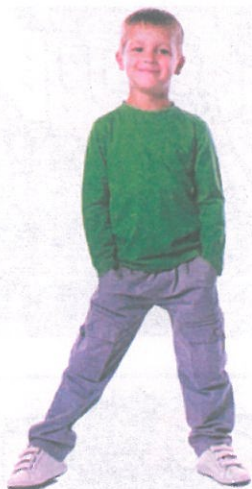

2



3



4



5



6





Listen and number. Say.

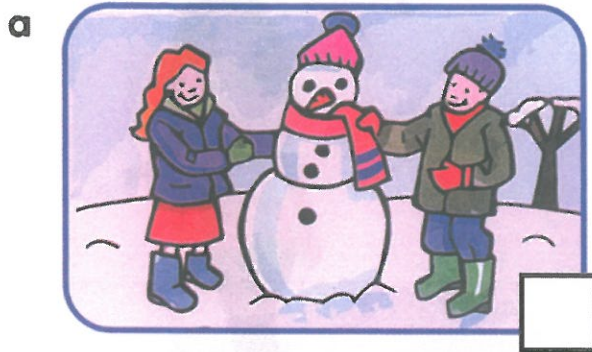







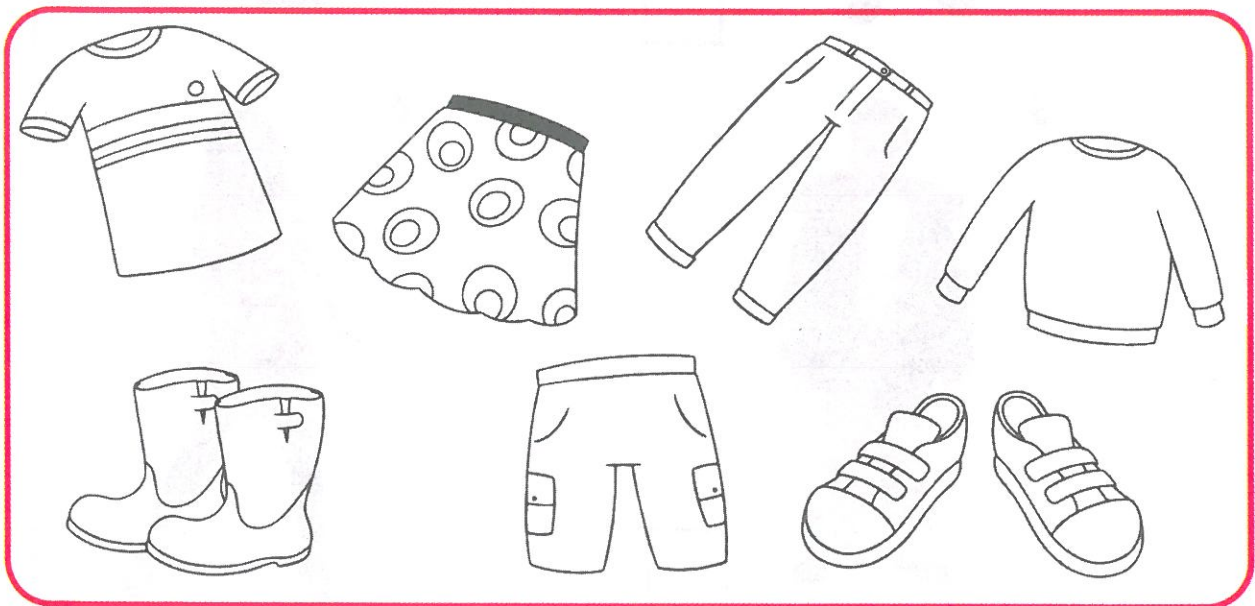

What are you wearing? Colour and say.



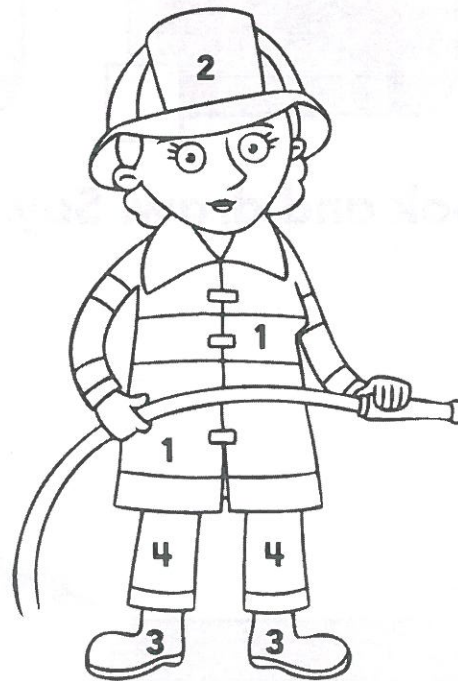
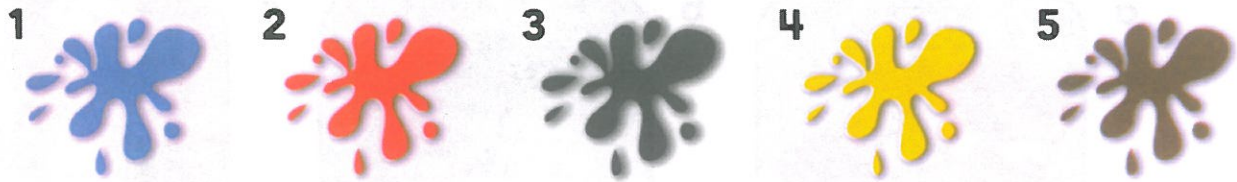

**7** Look and colour. Say.



**THINK BIG** Look and match.



3:17  
8

Listen and number.

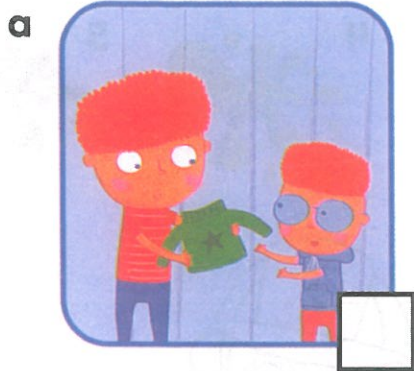

9

Look and draw. Say.

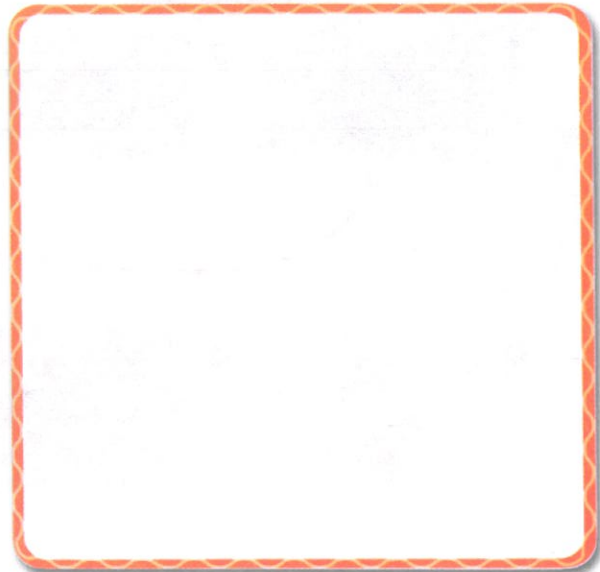



10 Look and match.



# unit 8

# My House



Listen and number.

a

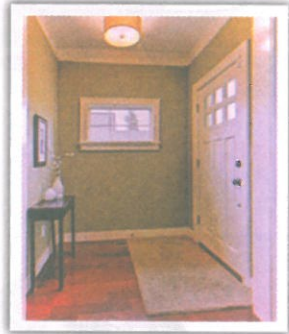

b



c



d



e



f



g



h





Look, listen and draw. Sing. 🎵

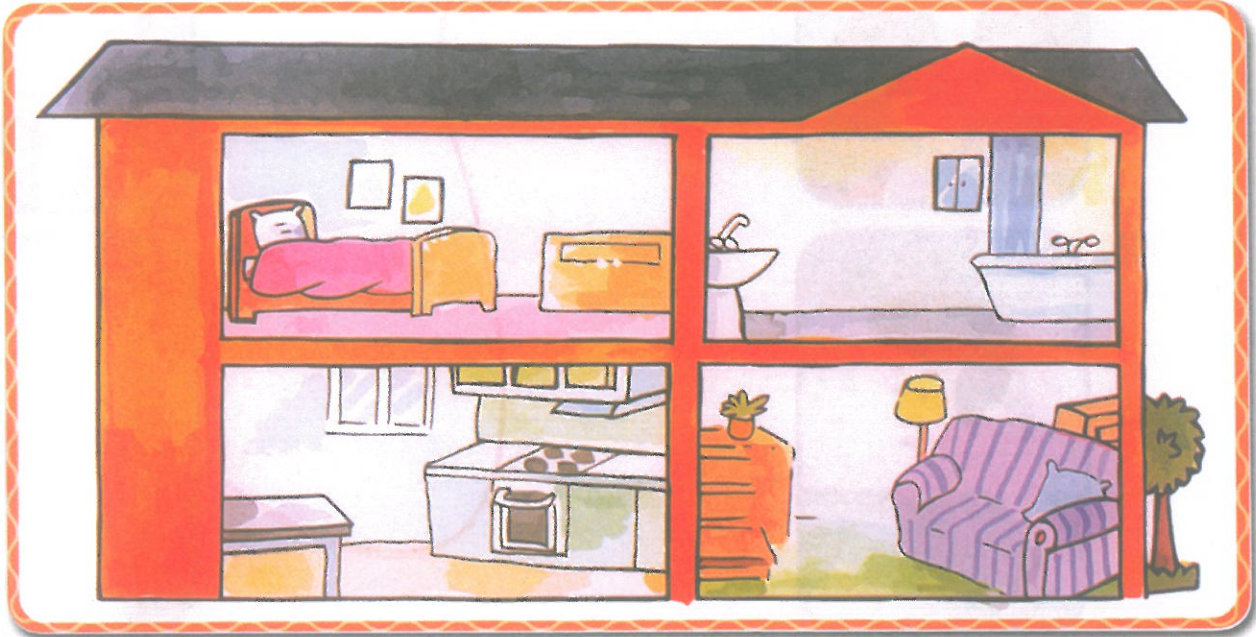

**THINK  
BIG**

Look and ✓. Say.

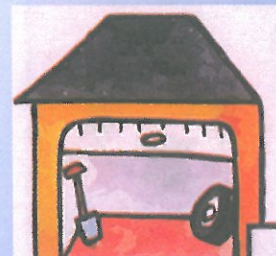
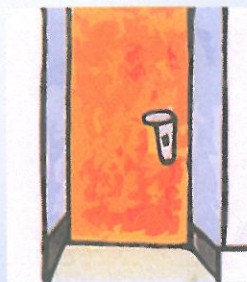
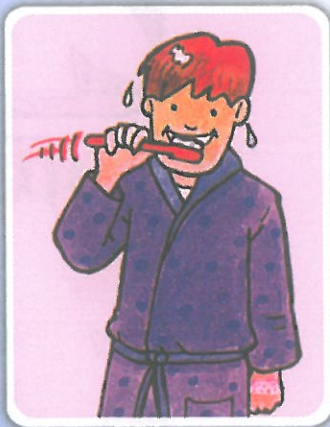



## 3 Match and say.

1



2



3



4



a



b

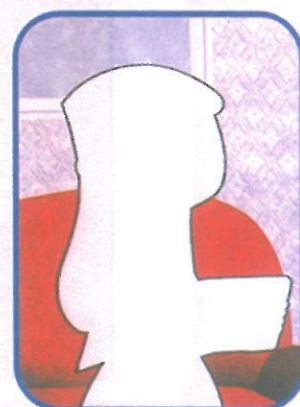

c

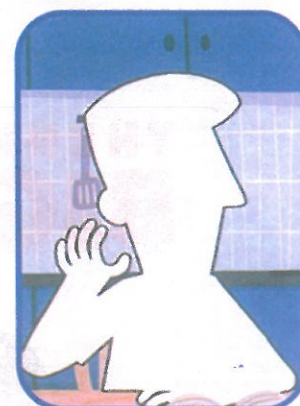

d

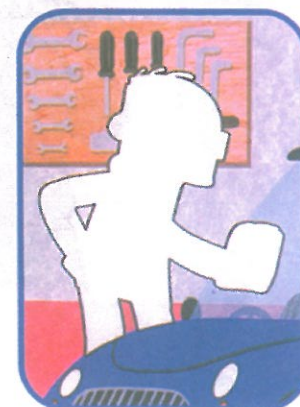





Listen and ✓ or X.

1



2



3



4



5











6





Listen and ✓.

				
1 			✓	
2 				
3 				
4 				



Draw and say.



موسسه زبان دهخدا  
dehkhodaedu.com



**7** Look and number. Say.

1



2



3



4

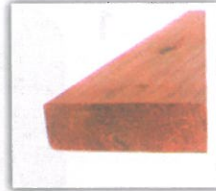

a



b



c



1

d



**THINK  
BIG**

Circle the odd one out. Say.





8 Look and circle.

1



2



3



4



5

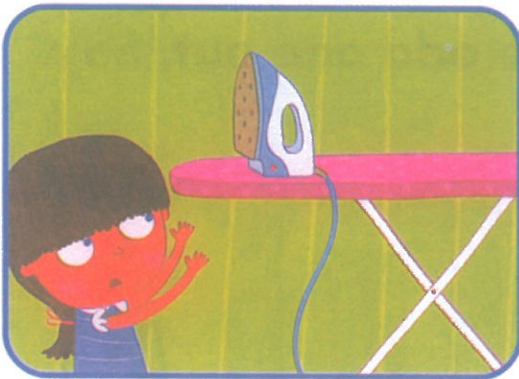

6





9 Find and colour. Say.

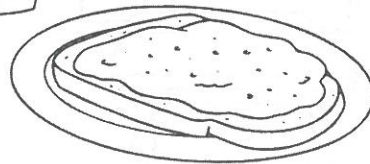
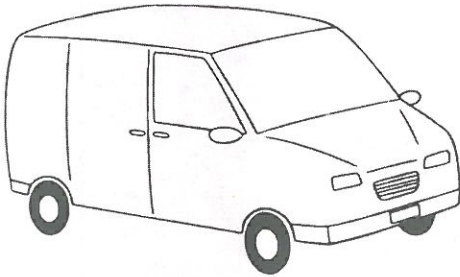
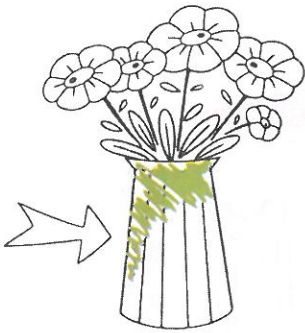

## 10 Complete and draw. Say.

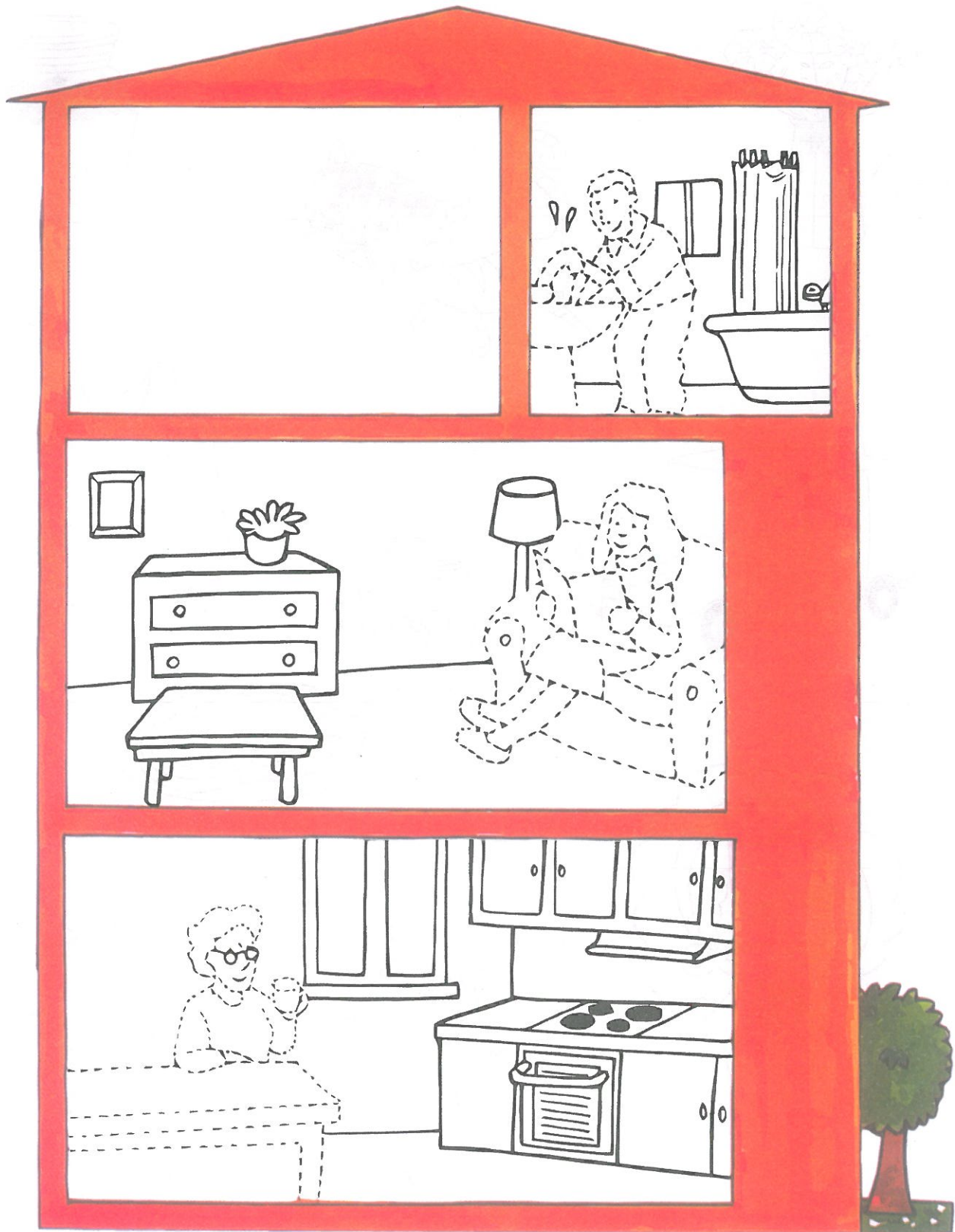





Listen and ✓.

1 a

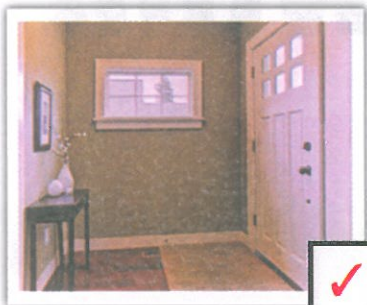

b



2 a



b



3 a



b

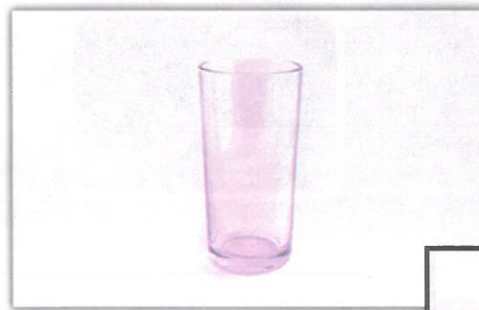

4 a



b



5 a



b

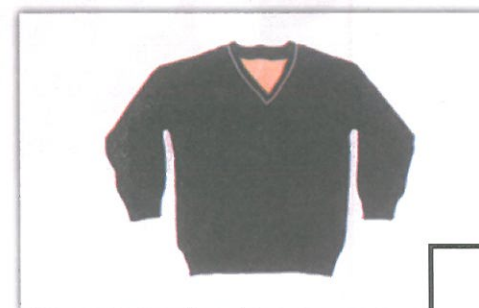



# unit 9

# A fish can swim!



Listen and follow.

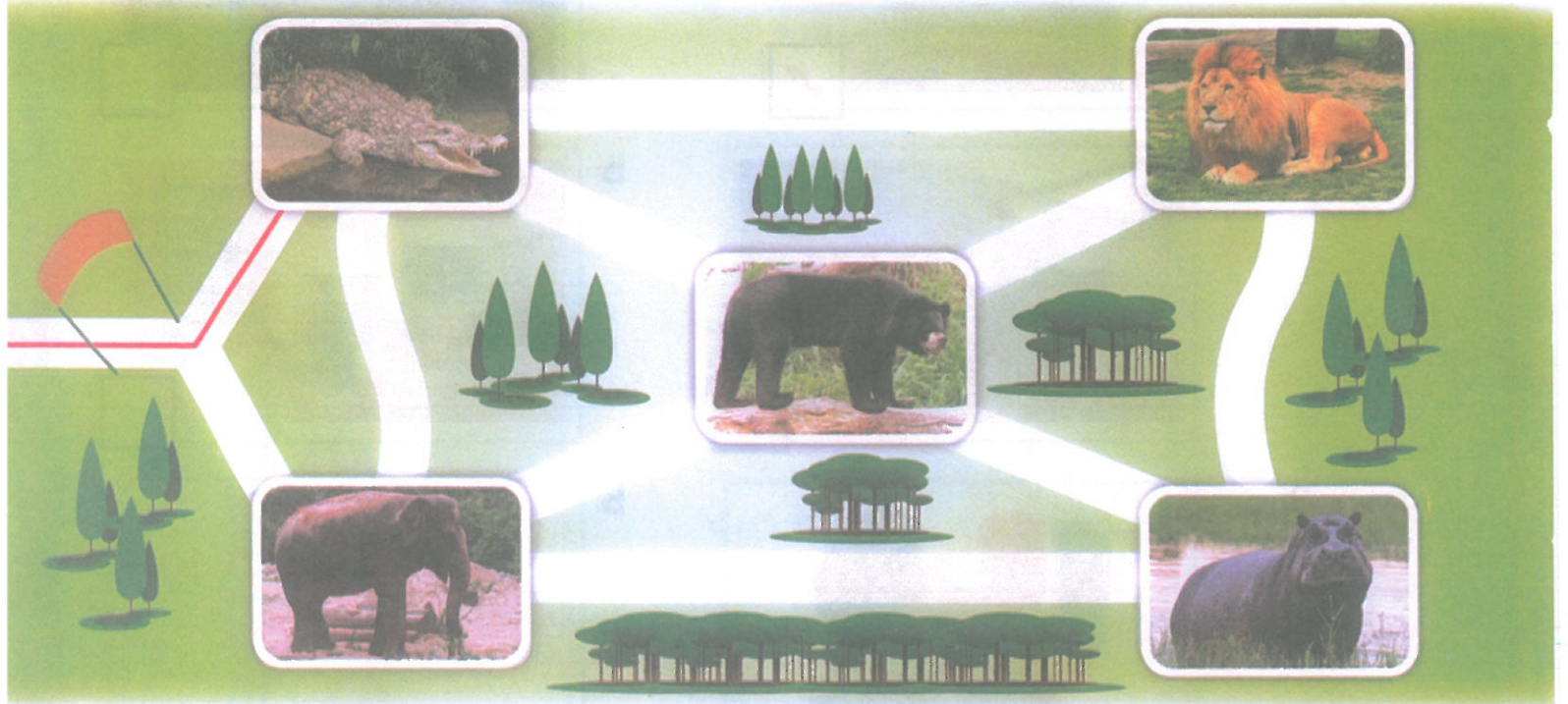

2 Count and dray. Say.

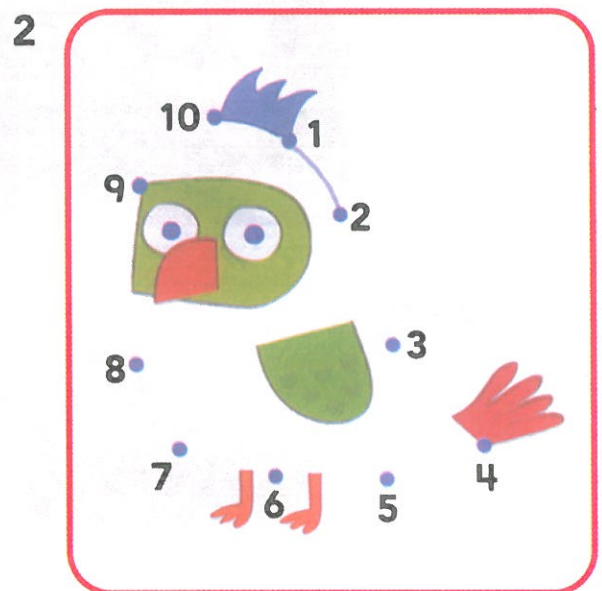
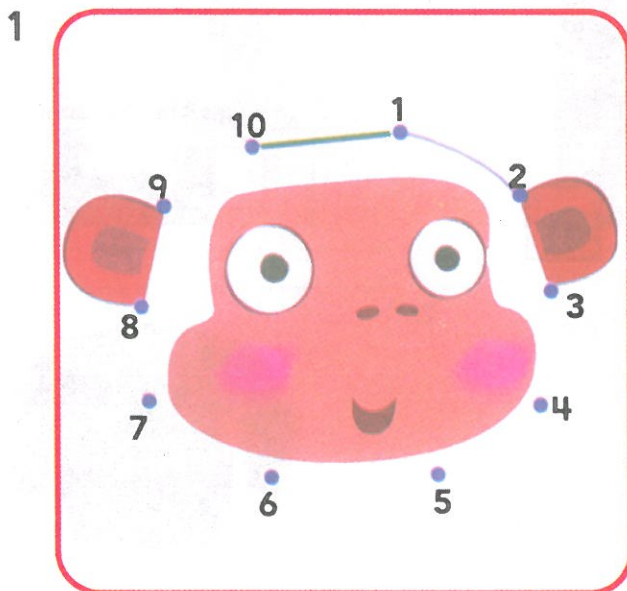



3:55  
5

Look and ✓ or X. Listen and check.

1

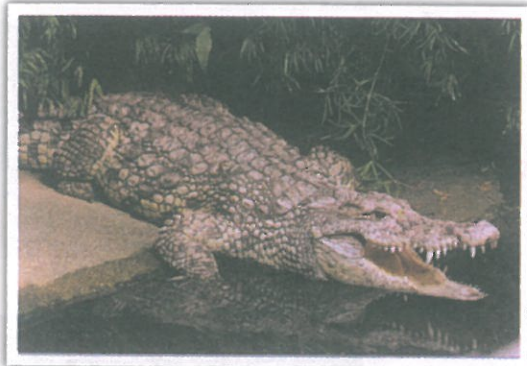

2



3



4



5



6





3:57  
6

Listen and circle.

1 a



b



2 a



b



3 a



b



4 a



b



7

Look and ✓ or ✗ for you. Say.













8 Look and draw. Say.

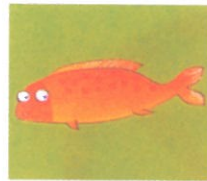

1

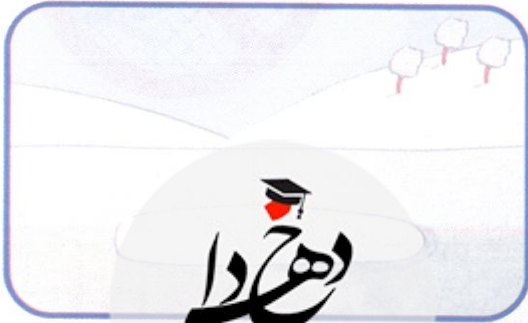

2



3



4

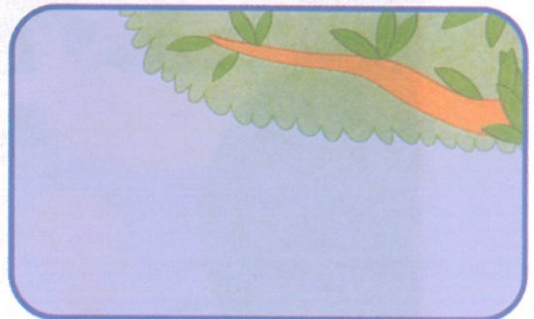

**THINK  
BIG**

Look and ✓. Say.

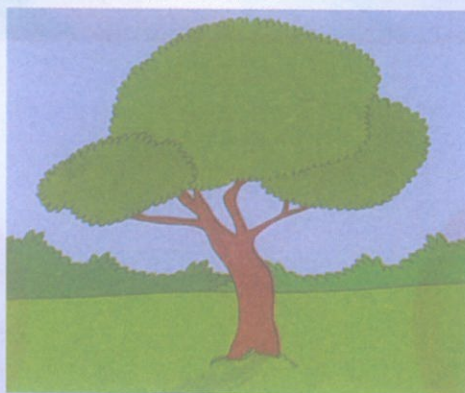

9 Look and match. Say.

1



2



3



4





10 Look and match. Say.

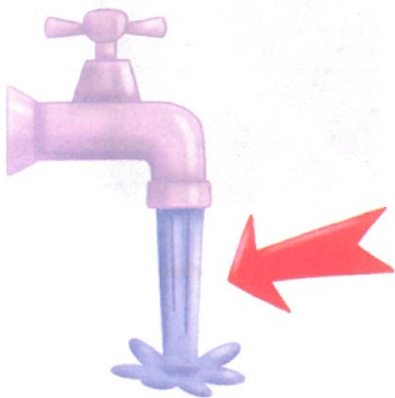

# Review

## 11 Look and ✓. Draw.

1



2



3





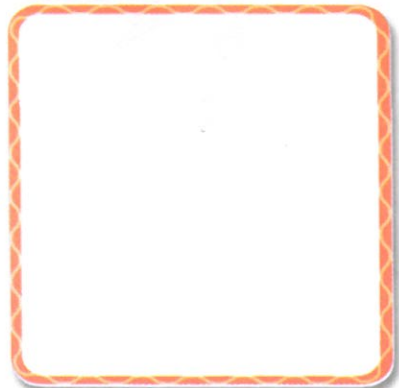





4





3.70  
3

Listen and ✓.

				
			✓	
				
				
				

4 Match and draw. Say.

1



3



5



2



4



6



## Unit 1 Stick and say.

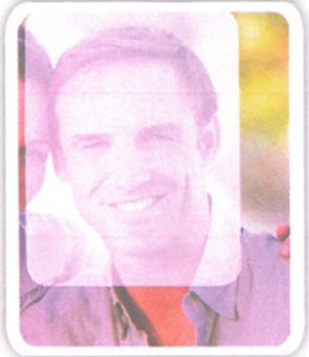

## Unit 2 Stick and say.





Unit 3 Stick and say.

Unit 3 Stick and say.



Unit 4 Stick and say.

Unit 4 Stick and say.

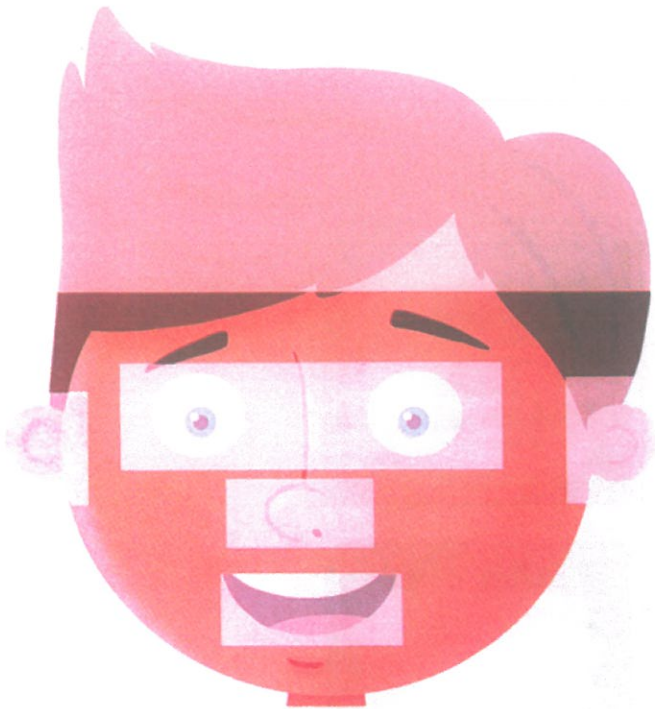

## Unit 5 Stick and say.



## Unit 6 Stick and say.





Unit 7 Stick and say.

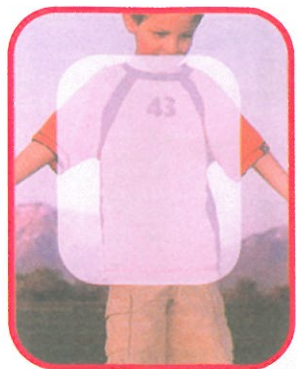



## Unit 8 Stick and say.

Unit 7 Stick and say.



## Unit 9 Stick and say.

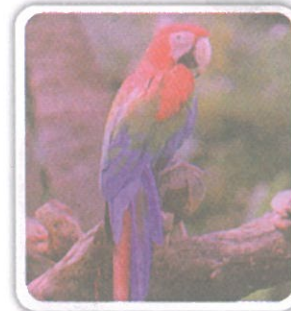



**Pearson Education Limited**

Edinburgh Gate

Harlow

Essex CM20 2JE

England

and Associated Companies throughout the world.

www.pearsonelt.com/bigenglish

© Pearson Education Limited 2014

The right of Linnette Ansel and Lisa Broomhead to be identified as the authors of this Work have been asserted by them in accordance with the Copyright, Designs and Patents Act 1988.

All rights reserved; no part of this publication may be reproduced, stored in a retrieval system, or transmitted in any form or by any means, electronic, mechanical, photocopying, recording, or otherwise without the prior written permission of the Publishers.

First published 2014

Fifth impression 2016

ISBN: 978-1-4479-5104-9

Set in Lab Avenir

Printed in Slovakia by Neografia

**Acknowledgements**

The publisher would like to thank the following for their contribution: Sagrario Salaberri for the Phonics pages.

The publisher would like to thank the following for their kind permission to reproduce their photographs:

(Key: b-bottom; c-centre; l-left; r-right; t-top)

**Alamy Images:** Chris Cooper-Smith 77 (a), Everyday Images 52tl, Stuart Forster 97r/6, Ingram Publishing 96tr, 104 (monkey), Peter Jordan\_NE 46l/2, 54cl, macana 46r/2, Borislav Marinic 60cl, 102tr, Maria Wachala 46r/4, 54l, Kevin Wheal 46l/3, 54r; **Art Directors and TRIP Photo Library:** Helene Rogers 41bl; **Corbis:** Blend Images / Jose Luis Pelaez, Inc. 5 (c), 12r/2, 81tl/2, 99/2, Flint 60cr, Jose Luis Pelaez, Inc 23l/2, Neumann & Rodtmann 12tr, 18/3, 28 (boy), Ocean 4l/4, 4r/1, 12r/3, 60br, 68r, 100tr, 103br, Tetra Images / Sarah M. Golonka 8bl, 12l/3; **DK Images:** Carolyn Barber 78 (d), 104tc, Dave King 17tl, 18cl, 100 (ball), 100bl, Stephen Oliver 100bc; **Fotolia.com:** A.Drean 92r/2, 97l/2, Africa Studio 24bl, 27bl, 28 (juice), 28 (pizza), 29cr, 83 (bottle), 101 (juice), 101 (pizza), amelie 92r/4, 97r/2, anankm1 88c, 97l/1, 99 (bear), 104 (bear), Galyna Andrushko 97l/3, ask4more 88tl, 91tl, 92l/1, 97r/4, 104br, bst2012 81tl/4, 81tl/6, cheri131 99 (bat), Matthew Cole 83/1, Cyril Comtat 88tr, 91bl, 96bl, 104 (lion), ep stock 46r/3, erasdesign 24br, 28 (tzatziki), 101tr, fengking 83/3, Eric Gevaert 92r/1, ingridd313 88br, 91tr, 92l/2, 96cr, 97l/4, 99 (hippo), 104 (hippo), iofoto 83 (a), Stephen Jones 52bl, kamonrat 91cr, 96tl, 99 (parrot), 104 (parrot), karandaev 29l, Kletr 91br, 92r/3, 96cl, 97r/5, 99bl, Kokhanchikov 83bl, 87l/3, Kzenon 60tr, legaa 27tr, Liaurinko 24tr, 28 (water), 101cr, lucielang 83 (glass), 87r/3, Paul Maguire 78 (c), 78 (e), 81br/1, 81br/4, 87r/2, 87r/4, 104 (kitchen), 104 (living room), Diana Mastepanova 83br, Mny-Jhee 27cl, Monkey Business 4l/2, 4r/3, 12c/2, 100tc, Oez 17bl, 18tr, 23b, 100 (puzzle), okinawakasawa 28 (cake), 101 (cake), Alena Ozerova 83/2, pioneer 29r, pisotckii 97l/6, Iriana Shiyon 78 (a), 78 (b), 81br/3, 81br/6, 87l/1, 87l/4, 99tl, 99tr, 104 (hall), 104tl, Comugnero Silvana 28 (fish), 101 (fish), sixore 88bl, 97r/1, 104bl, Nikolai Sorokin 17tr, 18tl, 23tl, 100 (car), Soyka 71tl, stootsy 27cr, 28 (ice cream), 101cl, Tinka 29cl, trekandshoot 78 (f), 81br/5, 87l/2, 99 (garage), 104tr, ulga 83/4, 87l/5, Viktor 24tl, 27br, 28 (chicken), 101tl, Eugen Wais 18cr, 23tr, 100 (train), wazymodo 102bl; **Getty Images:** Natalie Cass 23l/3, Muriel de Seze 83 (b), Fotosearch 12br, 28 (girl), Fuse 5t, 99/1, Glow Images, Inc 5 (a), 12l/2, 81tl/5, Leigh Howell Love 4l/3, 4r/2, 12bc, 100 (siblings), huronphoto 71cr, Jupiterimages 5 (d), 8tr, Rob Lewine 77 (d), Aaron Mccoy 83 (d), Britain On View / Eric Nathan 77 (f), Jose Luis Pelaez 13, Photodisc / Leland Bobbe 52tr, Doug Schneider 71cl, 77 (e), 101bl, 101br,

Stockbyte 23r/2, Elke Van de Velde 5 (b), 99/3, View Pictures / UIG via Getty Images 46l/1, 46l/4, 54cr; **Imagestate Media:** Paul Goldstein 92l/4; **Mediolmages:** 5cl, 8tl, 12bl, 18/2, 99/4; **Pearson Education Ltd:** Trevor Clifford 4r/4, 5c, 12tl, 18/1, 41tl, 41tr, 41br, 100 (boy), Terry Leung. Pearson Education Asia Ltd 17tc, 100br, Jules Selmes 23r/3, 78 (g); **PhotoDisc:** Kevin Peterson 45 (a); **Rex Features:** 87r/5, Michael McGurk 46r/1; **Shutterstock.com:** Nate Allred 68cl, 103tl, Petrenko Andriy 60bl, 102br, AVAVA 81tl/1, Olesya Feketa 60tl, 102tl, Matt Jeppson 91cl, 92l/3, 96br, 97l/5, 104 (snake), Donald Joski 45 (b), Konstantnin 97r/3, kurhan 8br, Osokina Liudmila 68l, 103tr, 103cl, Rob Marmion 81tl/3, marco mayer 27tl, Monkey Business Images 4l/1, 12tc, 100tl, ostill 45 (d), Pavel L Photo and Video 71bl, 77 (c), E. Petersen 78 (h), 81br/2, 87r/1, 99 (garden), 104 (garden), vvvita 45 (e); **SuperStock:** Blend Images 71br, 77 (b), Citizen Stock 71tr, Cultura Limited 52br, 83 (c), UpperCut Images 68cr, 103cr, 103bl

**Cover images:** Front: **Corbis:** Laura Doss c, Randy Faris cl, Wavebreak Media LTD cr; **SuperStock:** Fancy Collection l, RubberBall r

All other images © Pearson Education

Every effort has been made to trace the copyright holders and we apologise in advance for any unintentional omissions. We would be pleased to insert the appropriate acknowledgement in any subsequent edition of this publication.

**Illustrated by**

**Dani Cruz:** 2, 6-7, 16, 19 (b), 22 (b), 26, 38, 48, 58, 59 (t), 70, 80, 90;  
**Chantal Kees:** 5, 19, 20, 30, 33, 46-47, 49-51, 54-57, 59, 62, 64, -67, 72 (t), 79, 82, 86, 102; **Jose Rubio:** 3-5, 10, 14-15, 18, 22, 28-29, 34, 35 (t), 69 (b), 72 (c), 76 (b r), 98; **Christos Skaltsas:** 2 (b), 3 (c), 17, 21, 29 (t and b c), 31-32, 36-37, 40, 43, 44 (t), 53, 63, 72 (b), 73, 75-76, 85, 89 (t), 94 (c), 95; **Steven Wood (Advocate Art):** 9, 24-25, 35, 39, 41-42, 45, 61, 65, 69, 73 (b) 74, 84, 88 (b), 93, 103.

Share in your pupils' success  
Watch them excel in English

**Big English** prepares pupils for the challenges they will find in today's world:

- **CLIL**: because pupils are learning English and so much more
- **21st Century Skills**: because pupils want to get ahead and need to be prepared for the world around them
- **Assessment for Learning**: because confidence leads to success

Think **BIG** Dream **BIG**

# BIG ENGLISH



[pearsonELT.com/bigenglish](http://pearsonELT.com/bigenglish)

